

- » Keep the signal cables of the inverter away from the power cables as far as possible, or distribute the two categories of cables vertically-crossed if the distance is not far enough, otherwise it may cause signal interference.
- » Ensure that all the screws are tightened when wiring, otherwise damage to the inverter may occur.
- » The encoders and sensors should be applied with the shielded cables and the shielded layer should be grounded reliably.

Operation



- » Confirm that the wiring is completed and correct and then cover the plate before power on.
- » Do not open the plate after power on, otherwise electric shock may occur.
- » Operate the inverter appropriately, otherwise damage to the inverter may occur.
- » Non-professionals are not allowed to test the signals when the inverter is running. Otherwise, physical injury or damage to the devices may occur.
- » Do not change the parameters of the inverter at random, otherwise damage to the inverter may occur.



- » Do not touch the fans and brake resistors, otherwise it may cause mechanical injury or burn.
- » Do not start up or stop the inverter by power on or off, otherwise damage to the inverter may occur.
- » Ensure that the circuit breakers or contactors at the output sides of the inverter are not in output state before switching, otherwise damage to the inverter may occur.

Others



Warning

- » This inverter is not suitable for the occasions when the specifications exceed those specified in this manual. If you have special requirements, please contact our technical department.
- » The inverter is equipped with surge suppressors inside, which can protect it from the lightning. It is necessary to mount external surge suppressors at the power input side of the inverter in high lightning incidence areas.
- » When the conductors between the inverter and the motor exceed 100m, it is recommended to mount the output reactors to avoid overcurrent caused by excessive distributed capacitance.
 - » Do not mount the compensation capacitors and the surge absorbers at the output sides of the inverter. Otherwise, it may cause damage to the inverter due to overheating.
- » Mounting the input or output reactors, special filters and magnetic rings at the input or output sides of the inverter can effectively reduce the noise and thus avoid interference to other devices.
- » Non-professionals are not allowed to perform withstand voltage tests on the inverter, , otherwise damage to the inverter may occur.
- » Deal with the devices as industrial effluent after scrapping. Burning is strictly prohibited, otherwise an explosion may occur.
- » The cooling effect of the inverter is reduced and the electrolytic capacitor electrolyte is also volatile in high altitude areas, which will shorten the life of the inverter. Check the altitude of the actual usage site is below 1000m. If higher than 1000m, reduce 1% for every additional 100m.

CHAPTER 1 PRODUCT INFORMATION

1.1 Product model name rules

The letters and numbers of the type designation key indicate product series, voltage, power, load etc.

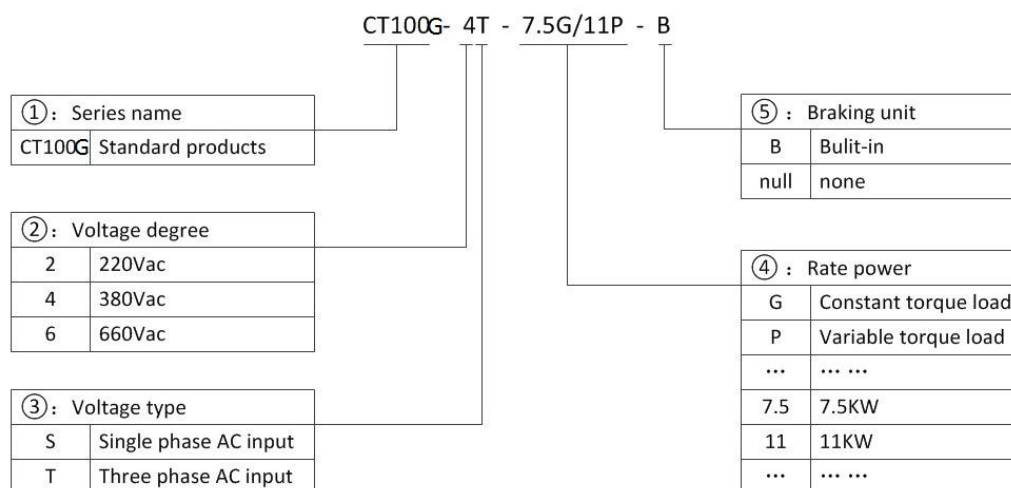

Figure 1-1 Type designation key

1.2 Product specifications and technical parameters

1.2.1 Product specifications

Table 1-1 Product Specifications

Inverter mode	Power (KW)	Input current (A)	Output current (A)	Applicable motor power (KW)
Single phase 220V 50/60Hz				
CT100G-2S-0.7G-B	0.75	8.2	4.5	0.75
CT100G-2S-1.5G-B	1.5	14.0	7.0	1.5
CT100G-2S-2.2G-B	2.2	23.0	9.6	2.2
CT100G-2S-4.0G-B	4.0	36.0	16.0	4.0
CT100G-2S-5.5G-B	5.5	46.0	20.0	5.5
CT100G-2S-7.5G-B	7.5	68.0	30.0	7.5
Three phase 380V 50/60Hz				
CT100G-4T-0.7G-B	0.75	3.4	2.5	0.75
CT100G-4T-1.5G-B	1.5	5.0	3.7	1.5
CT100G-4T-2.2G-B	2.2	5.8	5.3	2.2
CT100G-4T-4.0G-B	4.0	12.0	9.5	4.0

CT100G-4T-5.5G-B	5.5	18.5	14	5.5
CT100G-4T-7.5G-B	7.5	22.5	18.5	7.5
CT100G-4T-11G-B	11	30.0	25.0	11
CT100G-4T-15G-B	15	39.0	32.0	15
CT100G-4T-18.5G-B	18.5	45.0	38.0	18.5
CT100G-4T-22G-B	22	54.0	45.0	22
CT100G-4T-30G-B	30	68.0	60.0	30
CT100G-4T-37G	37	84.0	75.0	37
CT100G-4T-45G	45	98.0	92.0	45
CT100G-4T-55G	55	123.0	115.0	55
CT100G-4T-75G	75	157.0	150.0	75
CT100G-4T-90G	90	188.0	180.0	90
CT100G-4T-110G	110	221.0	215.0	110
CT100G-4T-132G	132	267.0	260.0	132
CT100G-4T-160G	160	309.0	305.0	160
CT100G-4T-185G	185	344.0	340.0	185
CT100G-4T-200G	200	384.0	380.0	200
CT100G-4T-220G	220	429.0	425.0	220
CT100G-4T-250G	250	484.0	480.0	250
CT100G-4T-280G	280	539.0	530.0	280
CT100G-4T-315G	315	612.0	600.0	315
CT100G-4T-355G	355	665.0	650.0	355
CT100G-4T-450G	450	805	795.0	450
CT100G-4T-500G	500	890	860.0	500
CT100G-4T-560G	560	1045	1015	560
CT100G-4T-630G	630	1224	1200	630

Note: 1. The inverters with power less than or equal to CT100G-4T-160G are equipped with braking units, but 37-160kw models are optional with or without braking units. And braking resistors inside whose power and resistance are as required as the table 2-2, otherwise has risk of damage. CT100G-4T-185G and bigger power models can be equipped with external braking units bought by customers themselves.

2. The above models are the standard general purpose inverters, excluding the industrial special inverters. You can customize non-standard inverters of other specifications.

1.2.2 Technical parameters

Table 1-2 Technical parameters

Input and output parameters	Input voltage	Single-phase 220VAC±15% Three-phase 380VAC±15%
	Input frequency	50~60Hz±5%
	Output voltage	0~Rated input voltage
	Output frequency	0~500Hz, unit 0.01Hz
	Overload capacity	150% of rated current: 60s; 180% of rated current: 10s; 200% of rated current: 1s
Running control parameters	Control mode	V/F control, sensorless vector control (SVC)
	Adjustable-speed ratio	1:100 (V/F); 1:200 (SVC)
	Speed control accuracy	±0.5%
	Speed wave	± 0.5%
	Start torque	0.5Hz/150% (V/F) 0.25Hz/150% (SVC)
Based functions	Starting frequency	0.00~10.00Hz
	ACC and DEC time	0.1~65000.0s
	Carrier frequency	0.5KHz~16.0KHz
	Frequency setting	UP/DOW setting, analog setting, digital setting, multi-step speed setting, PID setting, MODBUS communication setting, to realize switch of combination and channel setting.
	Start mode	Start frequency, DC braking and start
	Stop mode	DEC stop, free stop, DEC +DC braking
	Energy braking capability	Braking unit braking voltage:320~750V
	DC braking capability	DC braking frequency: 0~500Hz; DC braking waiting time: 0~10s; DC braking current: 0.0~100.0%; DC braking time: 0.0~100.0s;
	Auto voltage adjustment	Keep a stable voltage automatically when the grid voltage transients
Sudden frequency down	Keep stable bus voltage while power net low-voltage	
Control terminals	Digital input	Standard 8-channel inputs, one of which can be high-speed pulse input (HDI)
	Analog input	Standard 2-channel inputs, AI1: 0~10V or 0/4~20mA input optional, AI2:0V0~+10V

	Digital output	Standard 2-channel multi-function collector outputs, one of which can be high-speed pulse output (HDO).
	Relay output	Standard 2-channel relay outputs
Communication interface	RS485 Communication	RS485 communication interface for external communication, support Modbus protocol (RTU mode).
Fault protection		ACC overcurrent, DEC overcurrent, constant speed overcurrent, ACC overvoltage, DEC overvoltage, constant speed overvoltage, bus under voltage, motor overload, inverter overload, input power failure, output phase loss, rectifier module overheating, inverter module overheating, external fault, communication fault, current detection fault, EEPROM operation fault, PID feedback fault, factory setting time arrive etc.
Keypad display	LED display	Highlight LED digital tube displays the inverter information
Others	Running environment	Indoors, less than 1km above sea level, without dust, corrosive gases or direct sunlight
	Ambient temperature	-10~+40℃, derate 1% for every additional 1℃ when the ambient temperature is between 40~50℃
	Humidity	5~95% (no condensation)
	Altitude	0~2000m, derate 1% for every additional 100m when the sea level is above 1000m
	Vibration	Less than 0.5g
	Storage temperature	-40~+70℃
Control terminals	Digital input	Standard 8-channel inputs, one of which can be high-speed pulse input (HDI)

1.3 Product outline and installation size, weight

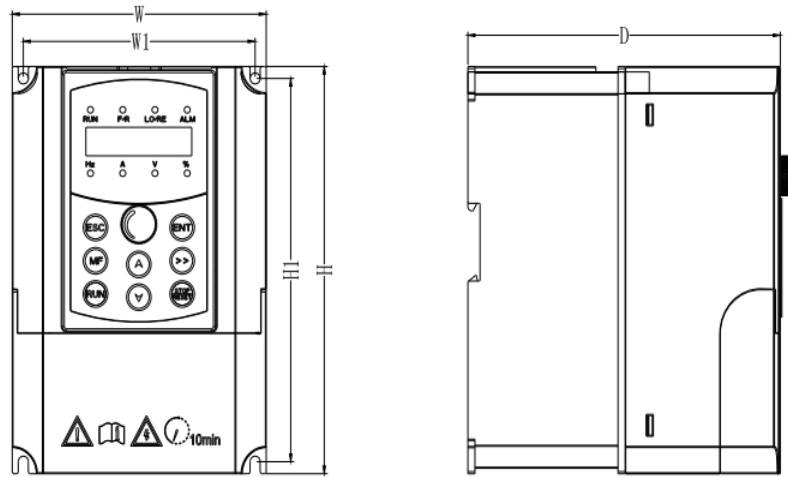

a) C0 models

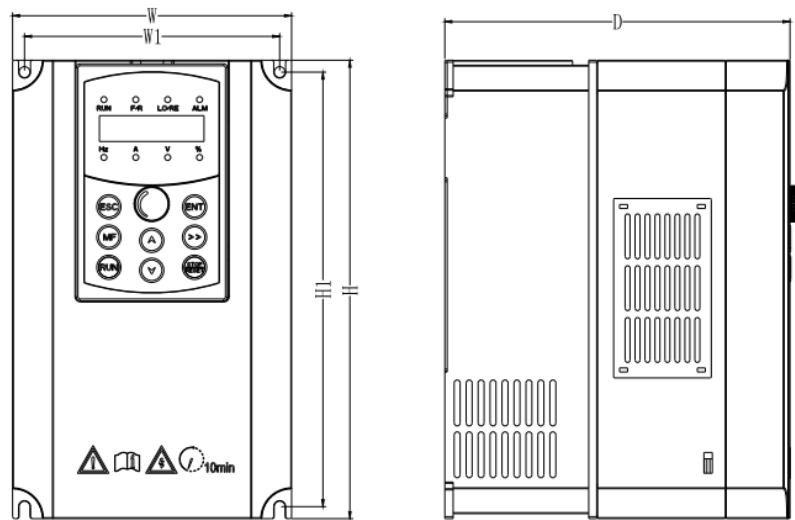

b) C1, C2 models

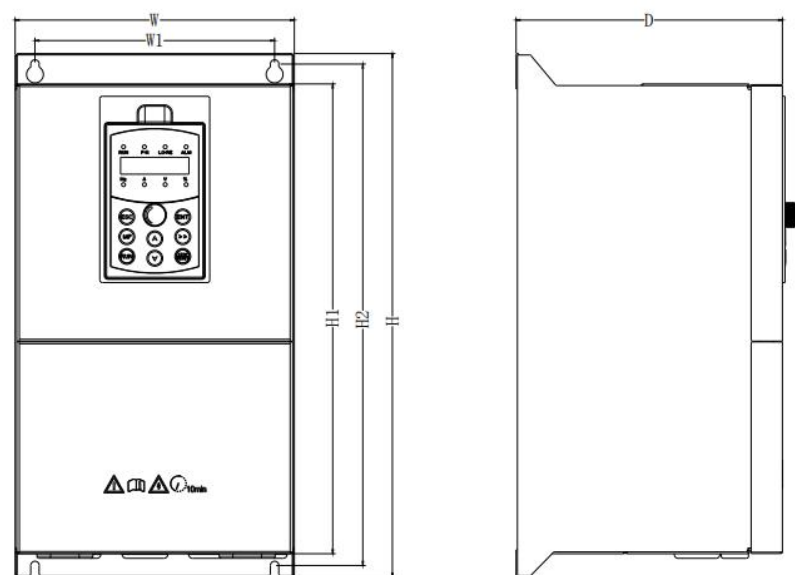

c) C3~C6 models

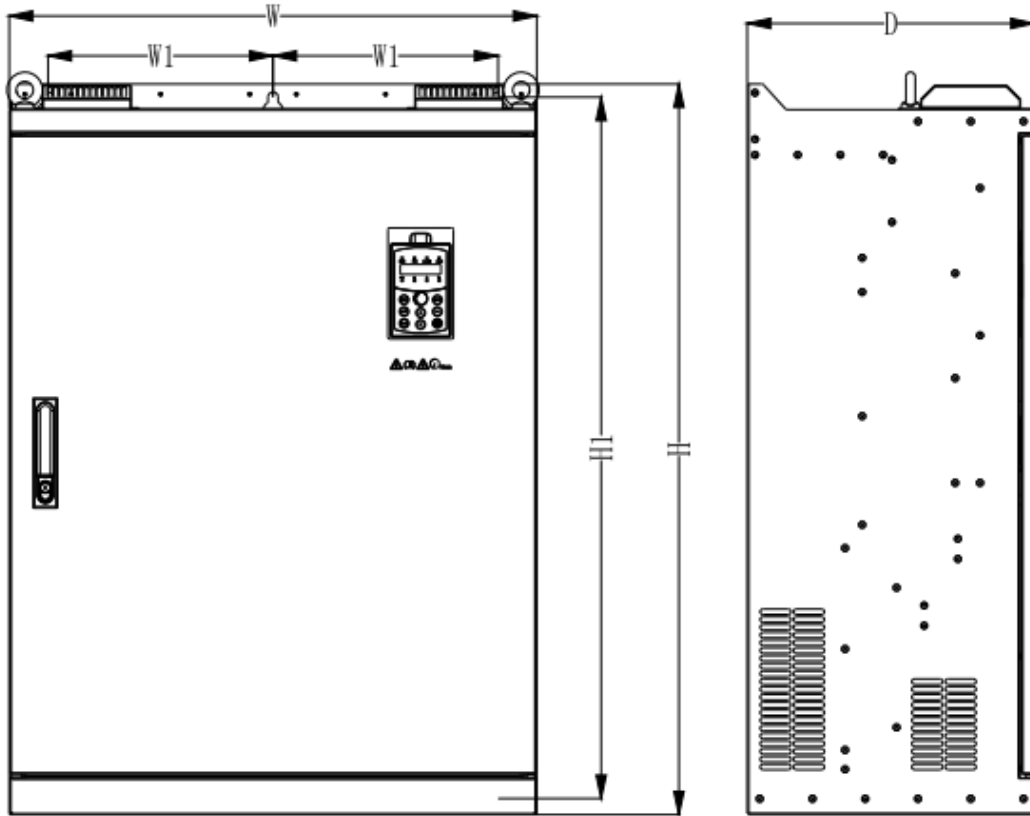

d) C7,C8 models

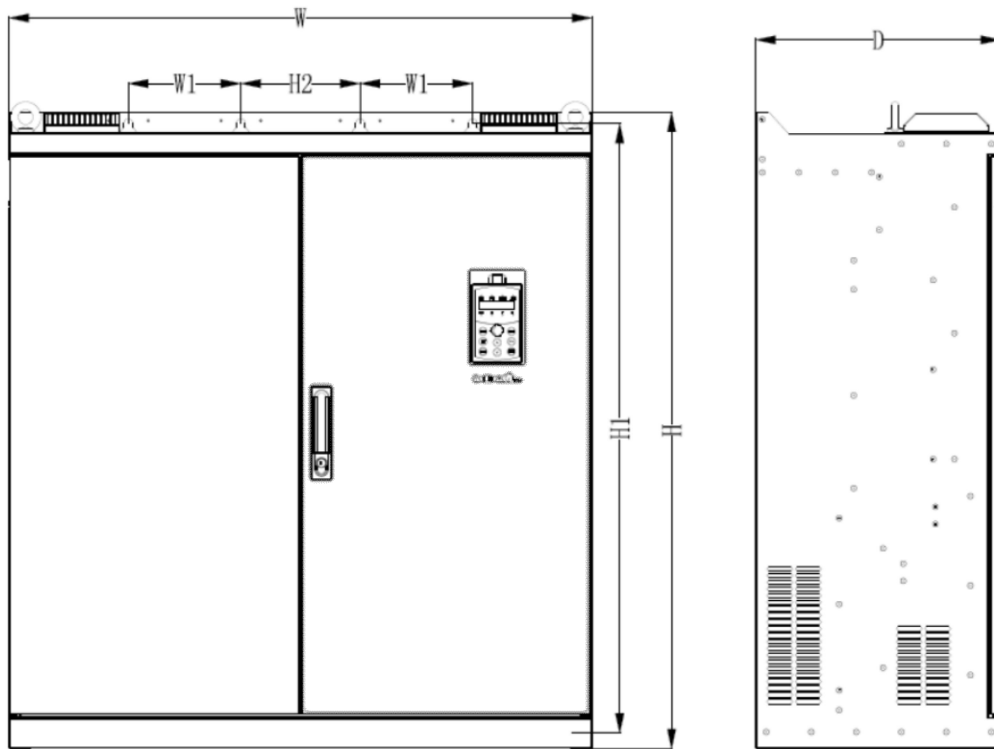

e) C11,C12 models

Figure 1-2 Product appearance and installation dimensions diagram

Table 1-3 Structure, mounting dimension and weight

Inverter mode	Appearance and dimensions (mm)						Installing hole(mm)	weight	cabinet
	W	H	D	W1	H1	H2			
CT100G-2S-0.7G-B	126	186	155	115	175	---	5	1.6	C0
CT100G-2S-1.5G-B									
CT100G-2S-2.2G-B									
CT100G-4T-0.7G-B									
CT100G-4T-1.5G-B									
CT100G-4T-2.2G-B									
CT100G-4T-4.0G-B									
CT100G-4T-5.5G-B									
CT100G-4T-7.5G-B	140	230	172	128	218	---	5.5	3.5	C1
CT100G-4T-11G-B	165	285	200	153	273	---	5.5	5.2	C2
CT100G-4T-15G-B									
CT100G-4T-18.5G-B	214	402	205	184	360	385	7	11.5	C3
CT100G-4T-22G-B									
CT100G-4T-30G-B									
CT100G-4T-37G	250	442	230	220	405	425	7	19	C4
CT100G-4T-45G									
CT100G-4T-55G	299	602	276	240	540	580	9	30	C5
CT100G-4T-75G									
CT100G-4T-90G									
CT100G-4T-110G									
CT100G-4T-132G	329	660	332	250	601	640	9	56	C6
CT100G-4T-160G									
CT100G-4T-185G	480	853	354	180	772	826	11	110	C7
CT100G-4T-200G									
CT100G-4T-220G									
CT100G-4T-250G									
CT100G-4T-280G									
CT100G-4T-315G	680	940	370	290	908	---	13	165	C8
CT100G-4T-355G									
CT100G-4T-400G									
CT100G-4T-450G	880	962	370	170	928	180	13	200	C11
CT100G-4T-500G									
CT100G-4T-560G	950	962	380	314	923	---	13	220	C12
CT100G-4T-630G									

1.4 Outline and size of keypad

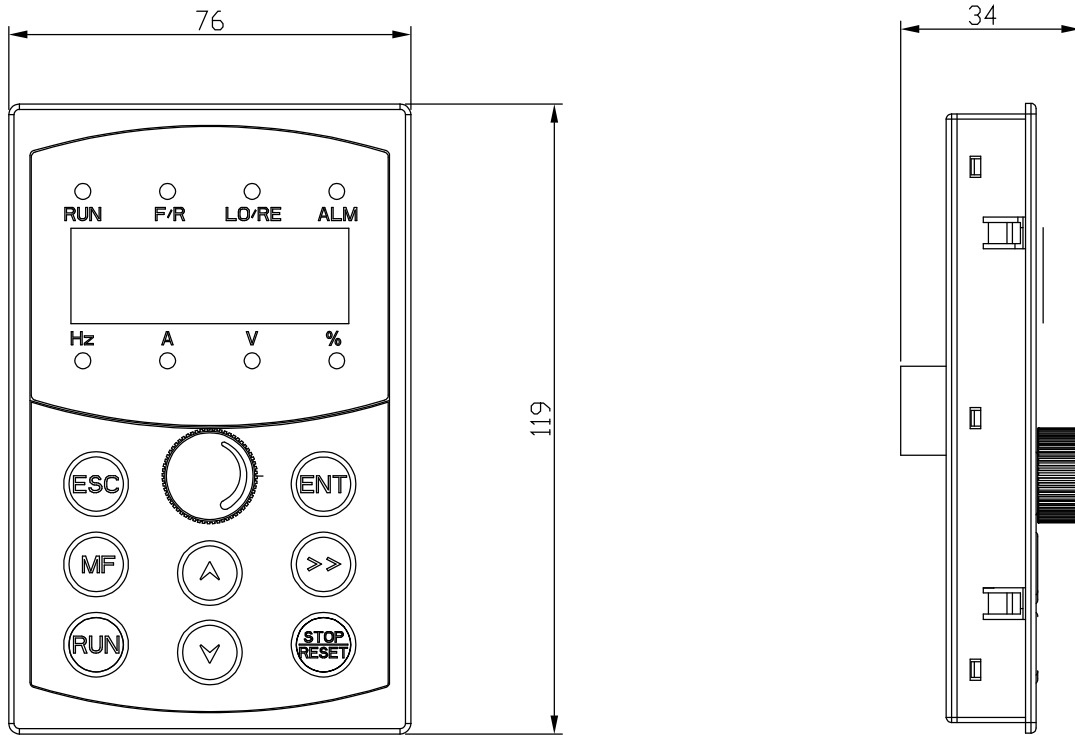

Figure 1-3 Structure diagram of the keypad (unit: mm)

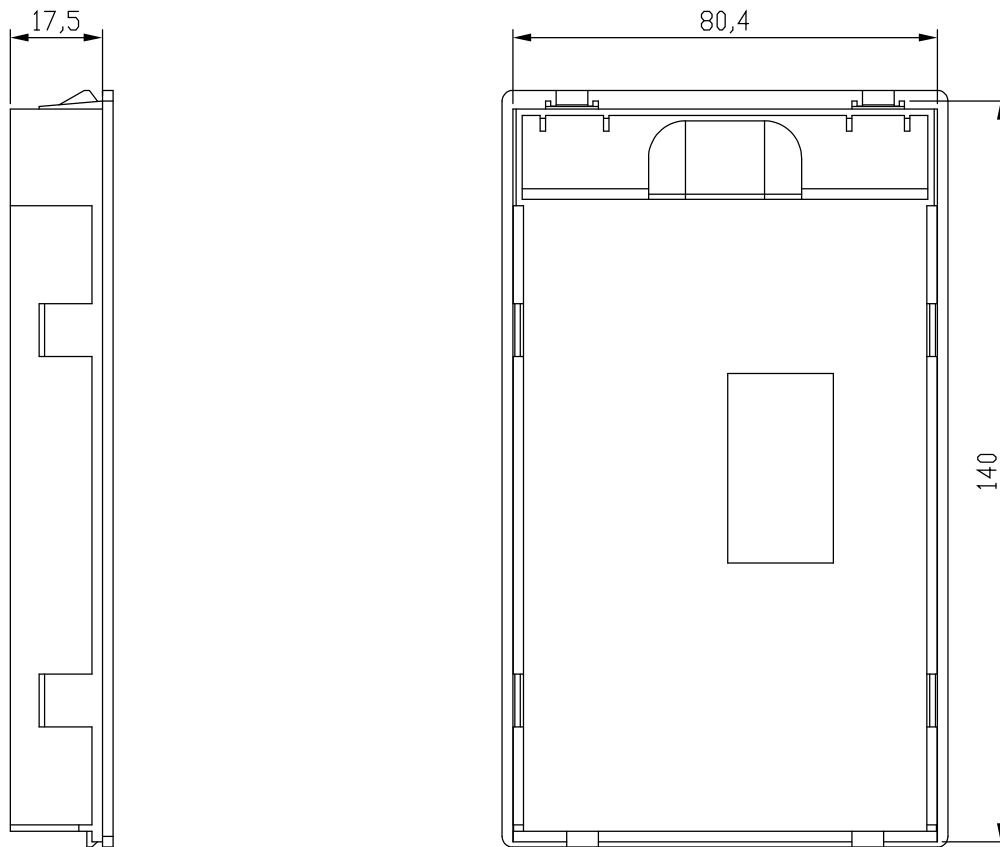

Figure 1-4 Structure diagram of the outer bracket (unit: mm)

Note: while use external keypad, the wire should not be more than 30m, otherwise there is risk of keypad not work.

CHAPTER 2 INSTALLATION AND WIRING

2.1 Installation environment

1. Ambient temperature: $-10^{\circ}\text{C} \sim +40^{\circ}\text{C}$, derate to use if the temperature is above 40°C
2. Relative humidity: $\leq 95\%$, no condensation
3. Vibration: $<0.5\text{g}$
4. The inverter should be installed on the flame-retardant materials and there is enough space for heat dissipation.
5. The inverter can output the rated power when the altitude is below 1000m. If the altitude is above 1000m, the output power will decrease. It is recommended to derate 1% for every additional 100m.
6. The inverter is not allowed to fall to the ground suddenly.
7. The inverter is not allowed to be installed near the electromagnetic radiation sources.
8. The inverter is not allowed to be installed in the atmospheres with flammable, explosive or corrosive gases.
9. The inverter is not allowed to be installed in the environments with direct sunlight, oil mist or steam.
10. Avoid screws, cables, drilling debris and other conductive matters falling into the inverter during installation, otherwise it may cause the inverter failure.
11. For the bad installation environments (like textile industry), it is recommended to install the radiator outside the cabinet.

2.2 Installation and disassembly of the keypad and the cover plate

2.2.1 Functions of peripheral components

Table 2-1 Functions of peripheral components

Name	Functions
Circuit breaker	Cut off the power and protect the latter when the latter devices have failure. Select the circuit breaker of the breaking current by 2 times of the inverter.
Leakage protector	PWM high frequency chopper voltage output causes high frequency leakage current, so select a special leakage protector.
Contactors	Frequent switching on-off the contactor causes inverter failure, so do not start or stop the inverter by switching on-off the main circuit, which will affect the life of the inverter.
Input reactor and DC reactor	Improve the input power factor; Reduce the impact on the system caused by the unbalance of input power; Suppress high harmonics and reduce external conduction; Suppress the interference on the rectifier bridge caused by the pulse current.
Input and output filters	Reduce the interference of the inverter on peripheral devices.
Braking unit	Consume the feedback energy from motors and brake rapidly

and braking resistor	during braking.
Output reactor	Reduce the protection of the inverter due to leakage current; When the cable connecting the inverter and the motor is more than 100m, it is recommended to install the output reactor.

2.2.2 Standard configuration of peripheral components

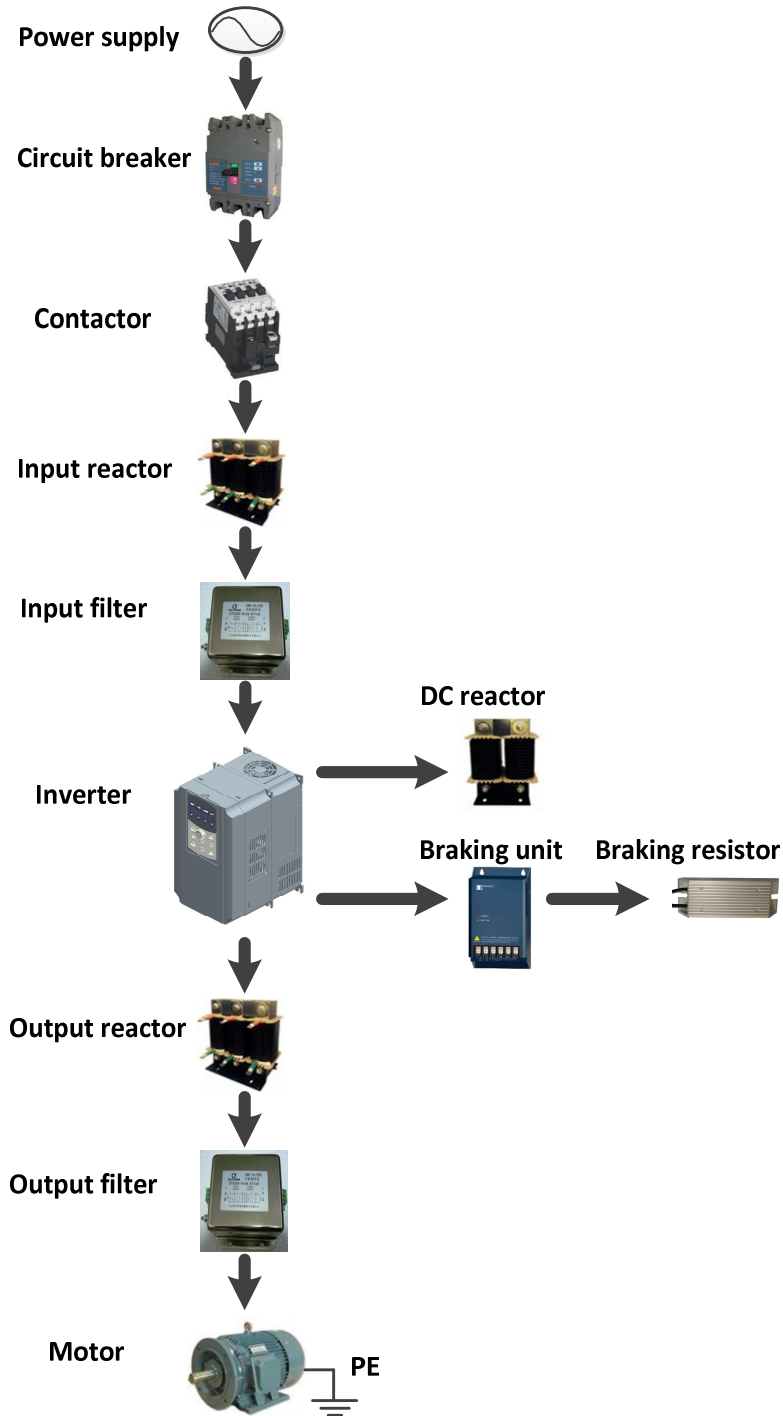

Figure 2-1 Standard peripheral components

2.2.3 Specifications of cables, circuit breakers and contactors

Table 2-2 Specifications of the cables, the circuit breakers and the contactors

Inverter mode	Cables (m ²)	Circuit breaker (A)	contactor (A)	Braking units&resistors	
				Power (KW)	Resist(Ω)
CT100G-2S-0.7G-B	2.5	16	10	≧ 0.3	≧ 200
CT100G-2S-1.5G-B	4	20	16	≧ 0.3	≧ 150
CT100G-2S-2.2G-B	4	32	25	≧ 0.3	≧ 85
CT100G-4T-0.7G-B	2.5	10	10	≧ 0.3	≧ 320
CT100G-4T-1.5G-B	2.5	16	10	≧ 0.3	≧ 250
CT100G-4T-2.2G-B	2.5	16	10	≧ 0.3	≧ 150
CT100G-4T-4.0G-B	4	25	16	≧ 0.75	≧ 85
CT100G-4T-5.5G-B	4	32	25	≧ 1	≧ 58
CT100G-4T-7.5G-B	4	40	32	≧ 1.3	≧ 43
CT100G-4T-11G-B	4	63	40	≧ 1.8	≧ 32
CT100G-4T-15G-B	6	63	40	≧ 2.5	≧ 25
CT100G-4T-18.5G-B	6	100	65	≧ 3	≧ 20
CT100G-4T-22G-B	10	100	65	≧ 5	≧ 17.5
CT100G-4T-30G-B	16	125	80	≧ 6	≧ 13
CT100G-4T-37G-B	16	160	80	≧ 7.5	≧ 10
CT100G-4T-45G-B	25	200	95	≧ 8.5	≧ 8
CT100G-4T-55G-B	35	200	125	≧ 12	≧ 7
CT100G-4T-75G-B	50	250	160	≧ 14	≧ 5.3
CT100G-4T-90G-B	70	250	160	≧ 16	≧ 4.5
CT100G-4T-110G-B	95	350	350	≧ 21	≧ 3.7
CT100G-4T-132G-B	150	400	400	≧ 26	≧ 3.3
CT100G-4T-160G-B	185	500	400	≧ 31	≧ 3.0
CT100G-4T-185G	240	630	400	External braking units and resistors are chosen according to braking units.	
CT100G-4T-200G	150*2	630	630		
CT100G-4T-220G	150*2	630	630		
CT100G-4T-250G	185*2	800	630		
CT100G-4T-285G	150*3	800	800		
CT100G-4T-315G	150*3	800	800		
CT100G-4T-355G	150*3	1280	960		
CT100G-4T-400G	150*4	1380	1035		
CT100G-4T-450G	150*4	1580	1185		
CT100G-4T-500G	150*4	1720	1290		
CT100G-4T-560G	185*4	2030	1525		

Inverter mode	Cables (m ²)	Circuit breaker (A)	contactor (A)	Braking units&resistors	
				Power (KW)	Resist(Ω)
CT100G-4T-630G	240*4	2400	1800		

Note: When the inverter is built-in with braking units, the power and resistance of the braking resistors should be as required above the table, otherwise the damage to the inverter may occur. Braking resistors are mounted externally, you need to purchase yourselves.

2.3 Main electric loop terminal

2.3.1 Functions of the main circuit terminals

Table 2-3 Functions of the main circuit terminals

Terminals	Function
R, S, T	Three-phase power input terminals
(+), (-)	Reserved terminals for external braking units, common DC bus terminals
(+), PB	Reserved terminals for external braking resistors
P1, (+)	Reserved terminals for external DC reactors
(-)	DC negative bus output terminal
U, V, W	Three-phase AC output terminals
⊕	Grounding terminal (PE)

2.3.2 Standard wiring diagram

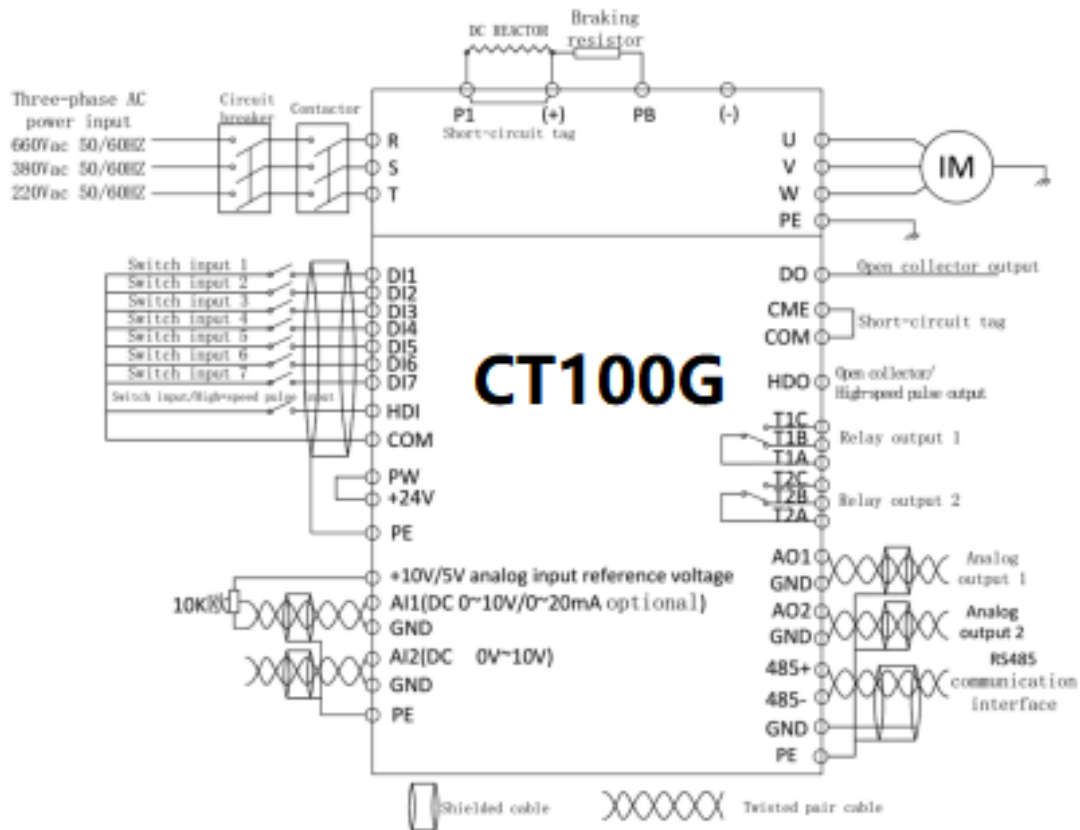

Figure 2-2 Standard wiring diagram

2.4 Control circuit connection

2.4.1 Precautions

Please apply the multi-core shielded cable or twisted pair to connect the control terminals. When using the shielded cable (near one side of the inverter), connect it to the PE terminal of the inverter. Keep the control cable away from the main circuit and strong power circuit (including power cables, motor cables, relays, contactors, etc.) more than 20cm. Vertical wiring is recommended instead of parallel wiring to prevent the inverter malfunction caused by external interference.

2.4.2 Schematic diagram of the control plate

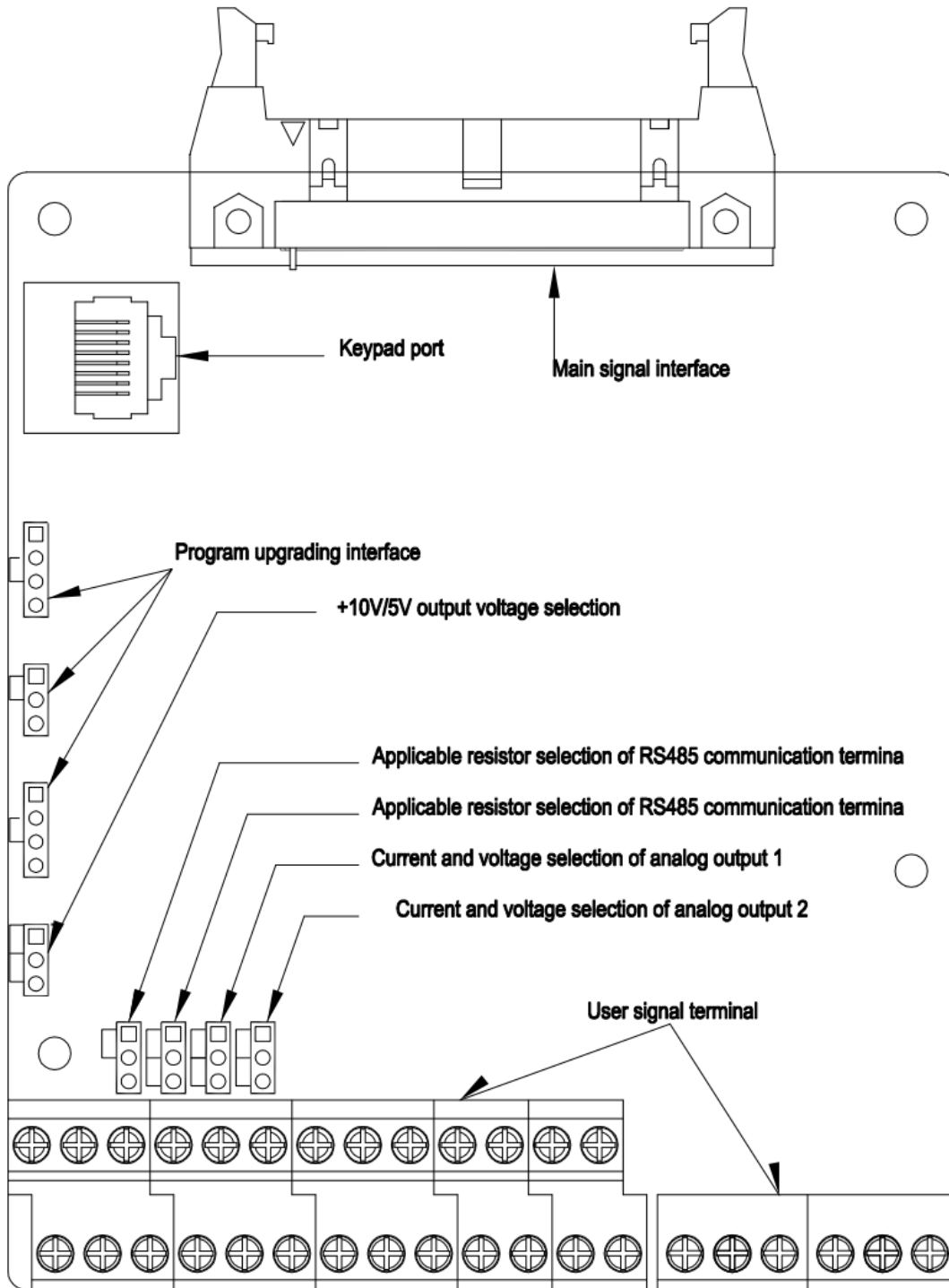
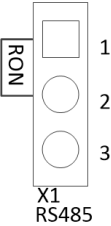
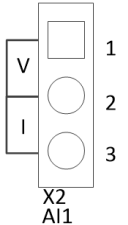
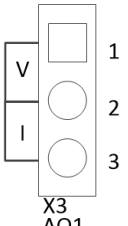
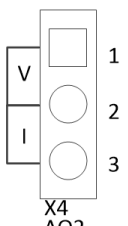
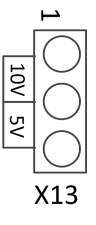

Figure 2-3 Schematic diagram of the control plate

2.4.3 Pins of the control plate

Table 2-4 Pin instructions of the control plate

No.	Instructions
X1	RS485 terminating resistor setting

		<p>Short circuit the pins 1 and 2 of X1 by short-circuit module, the terminating resistor of 120Ω is used for RS485 bus; Short circuit the pins 2 and 3 of X1 by short-circuit module, the terminating resistor is not used for RS485 bus; When the short-circuit module is not used, the terminating resistor is not used for RS485 bus.</p>
Analog input 1 voltage and current selection		
X2		<p>Short circuit the pins 1 and 2 of X2 by short-circuit module, the analog input 1 is voltage input (0~10V); Short circuit the pins 2 and 3 of X2 by short-circuit module, the analog input 1 is current input (0~20mA); When the short-circuit module is not used, the analog input 1 is voltage input (0~10V).</p>
Analog output 1 voltage and current selection		
X3		<p>Short circuit the pins 1 and 2 of X3 by short-circuit module, the analog output 1 is voltage output (0~10V); Short circuit the pins 2 and 3 of X3 by short-circuit module, the analog output 1 is current output (0~20mA).</p>
Analog output 2 voltage current selection		
X4		<p>Short circuit the pins 1 and 2 of X4 by short-circuit module, the analog output 2 is voltage output (0~10V); Short circuit the pins 2 and 3 of X4 by short-circuit module, the analog output 2 is current output (0~20mA).</p>
X1 3		<p>Short circuit the pins 1 and 2 of X13 by short-circuit module, the terminal +10V/5V supplies power +10V; Short circuit the pins 2 and 3 of X13 by short-circuit module, the terminal +10V/5V supplies power +5V.</p>
X6 X7 X8	Special pins for control board CPU downloading (factory set, unnecessary to change)	
X9	The interface of the main signal for connecting the signals between the control board and the power board	

2.4.4 Terminals of control circuit

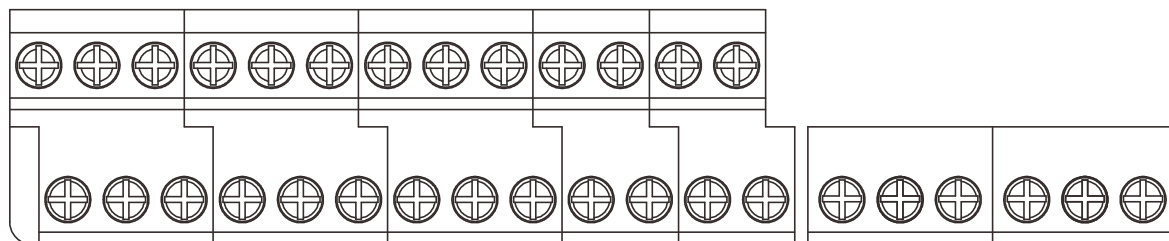

Figure 2-5 control board terminal ports

+10/5V	GND	AI1	AI2	COM	DI1	DI2	DI3	DI4	DI5	DI6	DI7	DO							
PE	485+	485-	GND	AO1	AO2	+24V	PW	COM	HDI	HDO	COM	CME	T1A	T1B	T1C	T2A	T2B	T2C	

Figure 2-6 control board terminal label

2.4.5 Functions of the main circuit terminals

Table 2-5 Functions of the control board terminals

Category	Terminal name	Terminal function	Technical specification
Switch input	+24V	+24V power supply	24V±10%, internal isolation from GND. Max. load 200mA
	PW	External power input terminal (power supply of digital input terminal)	Short circuit with +24V by default
	DI1~DI7	Switch input terminals 1~7	Input specifications: 24V, 5mA
	HDI	High speed pulse input or switch input	Pulse input frequency range: 0~50kHz High level voltage: 24V
	COM	+24V power supply or external power ground	Internal isolation from GND
Switch output	DO	Open collector output, common CME terminal	External voltage range: 0~24V
	CME	Common terminal of open collector output	Short circuit with COM by default
	HDO	High speed pulse output or open collector output, common COM terminal	Pulse output frequency range: 0~50kHz
	COM	HDO common terminal	Internal isolation from GND
Analog	+10/5V	The local supplies	Output voltage: 10V or 5V

input		+10V or 5V power output	available via X13, optional Output current range: 0~50mA (If the potentiometer is connected between +10V/+5V and GND, the resistance should not be less than 2kΩ.)
	AI1	Analog input terminal 1	Input voltage and current are optional Input voltage range: 0~10V Input current range: 0/4~20mA
	AI2	Analog input terminal 2	Input voltage range: 0~10V
	GND	Analog ground	Internal isolation from COM
Analog output	AO1~AO2	Analog output terminal	Output voltage and current are optional Output voltage range: 0~10V Output current range: 0/4~20mA
	GND	Analog ground	Internal isolation from COM
Relay output	T1A/T1B/T1C	Relay output	T1A-T1B: normally closed T1A-T1C: normally open Contact capacity: 250VAC/3A, 30VDC/1A
	T2A/T2B/T2C	Relay output	T2A-T2B: normally closed T2A-T2C: normally open Contact capacity: 250VAC/3A, 30VDC/1A
Communication interface	485+/485-	RS485 communication interface	RS485 communication interface

2.4.6 Wiring of switch inputs

By using the internal +24V power supply of the inverter, the wiring of the external controller for the NPN type sink current is as shown below:

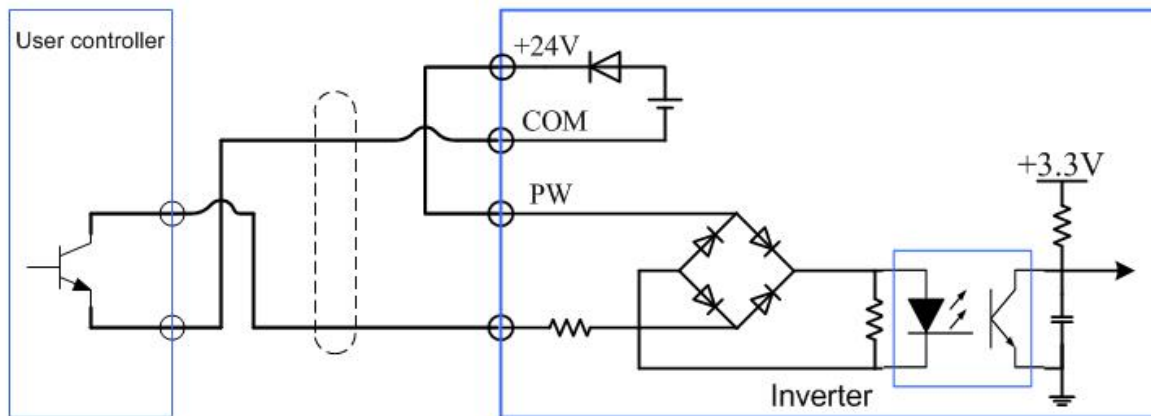

Figure 2-7 Wiring of NPN type sink current

By using the internal +24V power supply of the inverter, the wiring of the external controller for the PN type source current is as shown below:

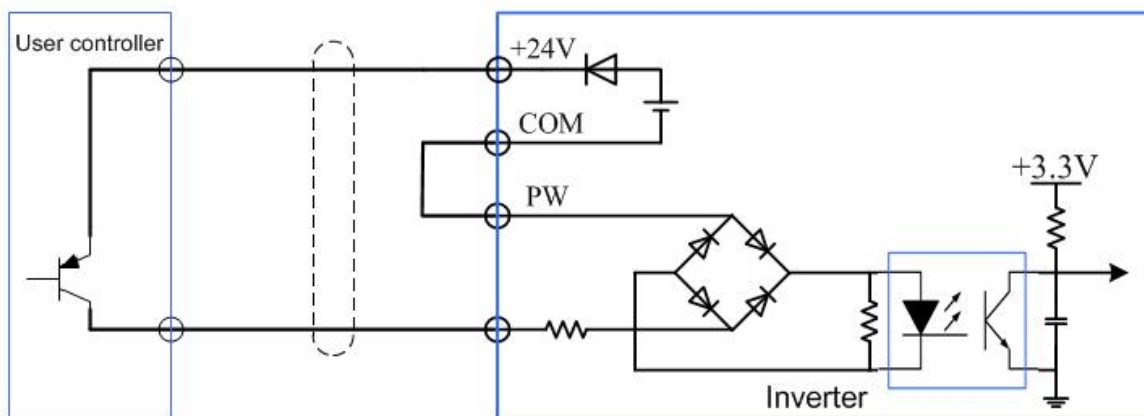

Figure 2-8 Wiring of PNP type source current

Note: Be sure to remove the short-circuit plate between +24V and PW and connect the plate between PW and COM.

By using the external power supply, the wiring of the external controller for the NPN type sink current is as shown below:

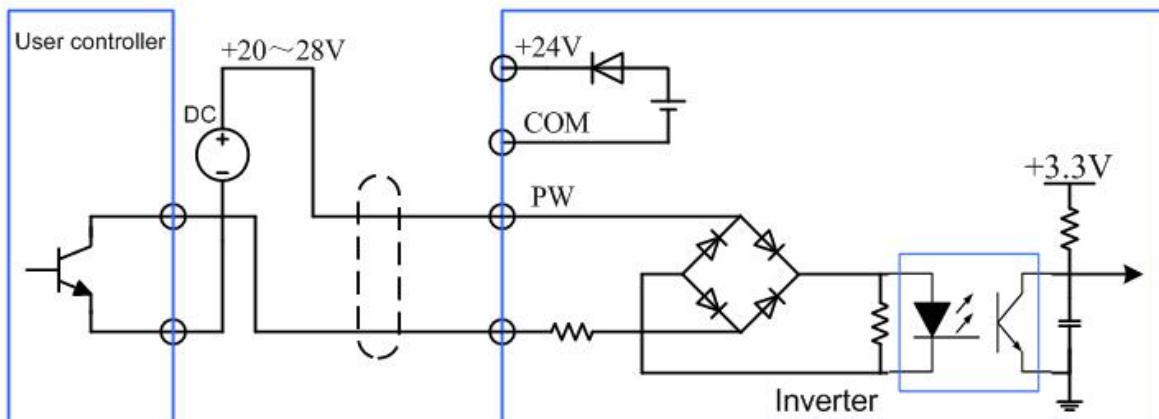

Figure 2-9 Wiring of NPN type sink current

Note: Be sure to remove the short-circuit plate between +24V and PW.

By using the external power supply, the wiring of the external controller for the PNP type source current is as shown below:

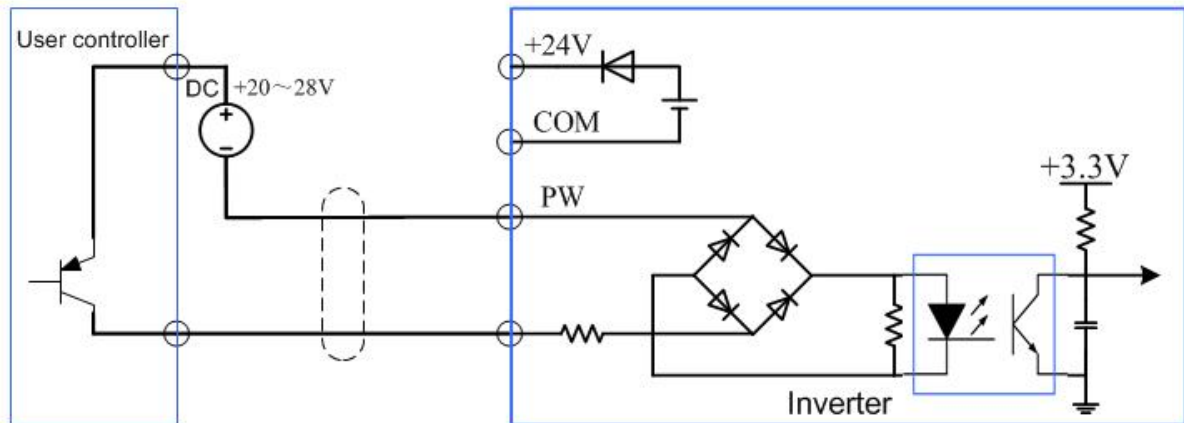

Figure 2-10 Wiring of PNP type source current

Note: Be sure to remove the short-circuit plate between +24V and PW.

CHAPTER 3 OPERATION AND POWER ON EXPLAIN

3.1 Keypad explain

The keypad consists of three parts for unit/status LEDs displaying, parameters displaying and key operation, as shown below.

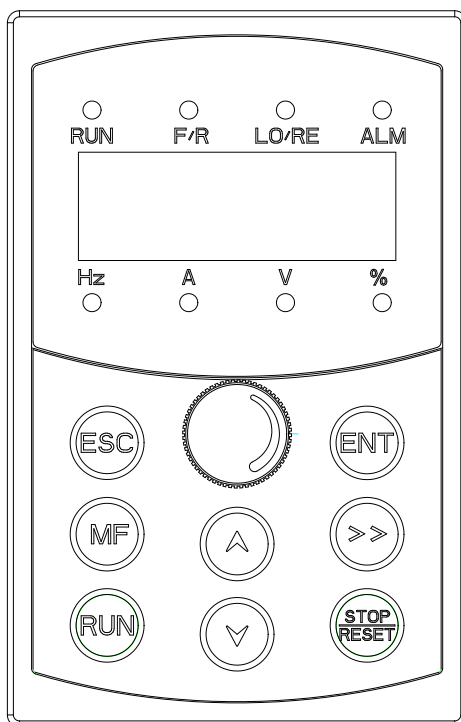

Figure 3-1 Keypad

3.1.1 Unit and status LED

Table 3-1 Unit and status LED indicator

	Symbol	Name	meaning
Unit LEDs	Hz	Frequency LED	The unit of the current displayed parameter is Hz.
	A	Current LED	The unit of the current displayed parameter is A.
	V	Voltage LED	The unit of the current displayed parameter is V.
	%	Percentage LED	The current displayed parameter is a percentage.
Status LEDs	RUN	Run status LED	On: The inverter is running. Off: The inverter stopped. Blinking: The inverter is in dormant state.
	F/R	Forward/Reverse LED	On: The inverter is in the reverse running state. Off: The inverter is in the forward running state or stopped.
	LO/RE	Run command reference LED	Off: keypad run command reference mode Blinking: terminal run command reference mode







		On: communication run command reference mode
ALM	Alarm LED	Off: no fault alarm Blinking: fault alarm or automatic study parameter On: torque control



3.1.2 Code displaying zone

5-figure LED display can display the monitoring data such as the set frequency and the output frequency and alarm codes.

3.1.3 Buttons

Table 3-2 Functions of buttons

Button	Name	Function
	Program ming/ Exit key	Enter or exit the 1st level menu; Return to the 1st level menu from the 2nd level menu; Return to the 2nd level menu from the 3rd level menu.
	Multi-func tion key	Operate according to multi-function selection [2]
	Run key	In the keypad run command reference mode, the key is used for start control of the inverter. After setting the parameter self-identification, the key is used to start the inverter for parameter self-identification.
	Enter key	After function group confirmation of the 1st level menu, enter the 2nd level menu; After function group confirmation of the 2nd level menu, enter the 3rd level menu; After function parameters setting confirmation of the 3rd level menu, return to the 2nd level menu; In password verification state, the password input is completed.
	Right-shift key	Function group edit step[1] selection in the 1st/2nd level menu; Function parameters settings edit step selection in the 3rd level menu; In stop parameter display status, running parameter display status and fault display state, display parameters selection; Edit bit selection in password verification state.
	Stop/Res et key	In keypad run command reference mode, the key is used for stop control of the inverter; In other run command reference modes, the key is used

		for stop protection of the inverter[3]; At fault or stop state, the key is used as a reset key to clear the fault alarm information.
	UP key	Increase function group in the 1st/2nd level menu progressively; Increase function parameters settings in the 3rd level menu progressively; Increase the set frequency progressively.
	DOWN key	Decrease function group in the 1st/2nd level menu progressively; Decrease function parameters settings in the 3rd level menu progressively; Decrease the set frequency progressively.
	Potentiometer	Adjust the frequency; Adjust the torque.

Note: [1] Select the edit step to be ones, tens or hundreds via the right-shift key.

[2] See function code (F05.04) for multi-function selection.





[3] After sending a stop command, you need to run the clear command in the current run command reference mode.

3.2 Operation process

3.2.1 Parameter setting

The three-level menu is:

1. Group number of function code (first-level menu);
2. Tab of function code (second-level menu);
3. Set value of function code (third-level menu).

Note: 8.8.8.8.8 is displayed initially after power on and the digital reference frequency is displayed after initialization. When you need to modify the parameters, press **ESC** to enter the first-level menu and F00 will be displayed. Modify the function group by  or  to F00-F15, press **ENT** to enter the second-level menu, press **ENT** key again to enter the third-level menu, modify the parameters by  or , press **ENT** to write into the control board and press **ESC** to return.

In the third-level menu, if the bit of the parameter is not blinking, it is unmodifiable, the reasons may be:

- 1) The function code is an unmodifiable parameter, such as the actual detection parameters, fault record parameters, operating record parameters etc.
- 2) The function code cannot be modified in the running state.

3.2.2 Fault reset

After the inverter has fault, the inverter will inform the relevant fault information. You can reset the inverter via the **STOP/RESET** key or the fault reset terminal (F6). The inverter will be in standby mode after fault reset. If the inverter is in a fault state and you do not reset it, the inverter cannot run and remains in the running protection state.

3.2.3 Motor parameter self-identification

To obtain good control performance, the motor must be self-identification of the parameters to obtain the exact parameters of the controlled motor; you must input correct motor parameters according to the name plate before identification, CT series inverters will match the parameters with the standard motor parameters.

The operation procedures for motor parameters identification are as follows:

First, select the keypad run command mode for the run command (F00.01).

Then enter the following parameters according to the actual motor parameters:

F01.02: Rated motor power;

F01.03: Rated motor frequency;

F01.04: Rated motor speed;

F01.05: Rated motor voltage;

F01.06: Rated motor current.

Note: The motor should be decoupled from the load. Otherwise, the identification parameters may be incorrect. Set F01.12 to 1, if the motor is not decoupled from the load, set F01.12 to 2 (see description of Function code F01.12 for detailed motor identification) and then press the **RUN** key, the inverter will automatically calculate the following parameters of the motor:

F01.07: Motor stator resistance;

F01.08: Motor rotor resistance;

F01.09: Motor stator and rotor inductance;

F01.10: Motor stator and rotor mutual inductance;

F01.11: Motor no-load current;

After the motor parameter identification is completed, the digital tube displays END, otherwise the self-identification failed.

3.2.4 Password setting

CT series inverters provide user password protection function. When F05.03 is set to non-zero, which is the user password. Exit the editing status of function code and password protection will take effect in 60s. Press the ESC key again to enter the editing status of function code and "8.8.8.8" will be displayed. You need to input correct user password, or cannot enter.

To disable the password protection function, set F05.03 to 0.



3.3 Display parameter

3.3.1 Running state



In the running state, the inverter has a total of 19 state parameters to be selected whether to display, including the running frequency, set frequency, bus voltage, output current, output voltage, running speed, linear speed, output power, output torque, input and output terminal status, PID reference, PID feedback, high speed pulse HDI frequency, count value, PLC and multi-step speed, torque setting, potentiometer value, AI1, AI2, motor overload percentage, inverter overload percentage etc. The parameters can be selected by F05.08 and F05.09 in binary bit. Press the **»** key to switch to the right to display the selected parameters, press the **MF** key to switch the left to display the selected parameters.

3.3.2 Standby state

In the stop, fault and running state, a variety of status parameters can be displayed. The parameter can be selected by F05.10 in binary bit.

In the stop state, the inverter has a total of 10 state parameters to be selected whether to display, including the set frequency, bus voltage, input and output terminal status, potentiometer value, AI1 , AI2, high speed pulse HDI frequency, PID reference, PID feedback, PLC or multi-step speed etc. The parameters can be selected by F05.10 in binary bit. Press the  key to switch the selected parameters in the right and press the  key to switch the selected parameter in the left.

















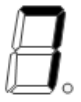









3.3.3 Fault state

In the fault state, both the fault state and the stop state will be displayed. Press the  key to switch to the right to display the selected parameters, press the  key to switch the left to display the selected parameters.

CT100G series inverters provide a variety of fault information. Please refer to chapter 6 fault reason and solution.

3.4 Keypad LED display meaning

Table 3-2 Displayed words

Displayed word	Meaning	Displayed word	Meaning	Displayed word	Meaning	Displayed word	Meaning
	0		1		2		3
	4		5		6		7
	8		9		A		b
	C		d		E		F
	H		I		L		N
	o		P		S		T
	U		V		.		

3.5 First time power on

Please carry out wiring in accordance with the technical requirements in Chapter 3. The flow time power on at the first time is as follows:

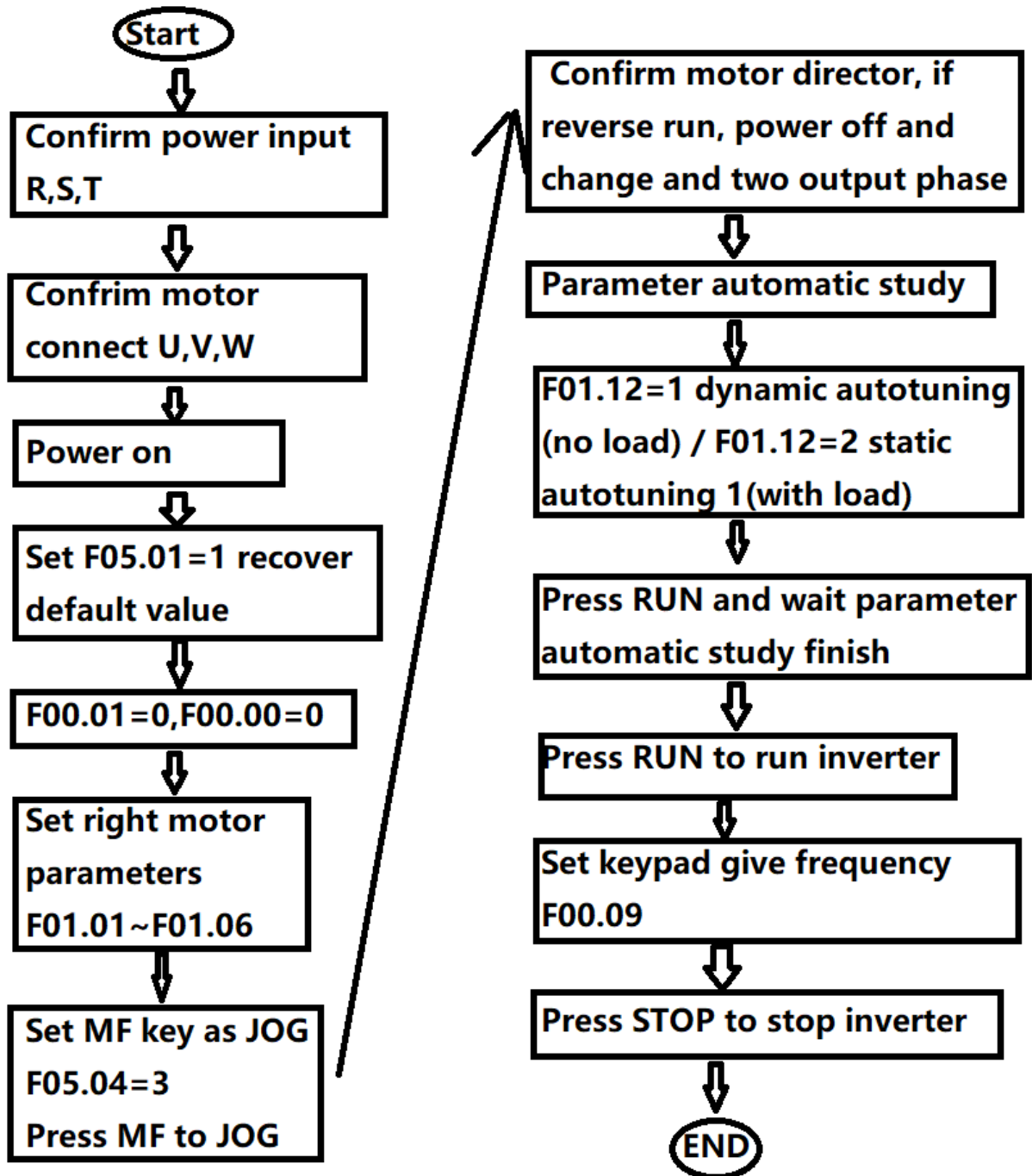

Figure 3-3 First power flow chart

CHAPTER 4 FUNCTION PARAMETER TABLE

CT100G series inverters have 16 groups of function codes F00~F15 and factory group F16. The function codes have been divided into three levels. For example, "F08.08" means the eighth function code in the P8 function group. F15 group is factory group, and users are forbidden to access these parameters.

For the convenience of function codes setting, the function group number corresponds to the first level menu, the function code corresponds to the second level menu and the function code parameter corresponds to the third level menu.

1. Below are the instructions of the tables for function codes:

The first line "Function code": codes of function parameter group and parameters

The second line "Name": full name of function parameters

The third line "Detailed instruction of parameters": Detailed illustration of the function parameters

The fourth line "Default value": the original factory set value of the function parameters

The fifth line "Modify": the modifying character of function codes (the parameters can be modified or not and the modifying conditions), below are the instructions:

"○": means the set value of the parameter can be modified in stop and running state;

"☆": means the set value of the parameter cannot be modified in running state;

"●": means the value of the parameter is the real detection value which cannot be modified.

(The inverter has limited the automatic inspection of the modifying character of the parameters to help users avoid modifying by mistake)

The sixth line "No.": the serial number of the function parameters

2. "Parameter radix" is decimal (DEC), if the parameter is expressed by hex, then the parameter is separated from each other when editing. The setting range of certain bits are hex (0~F).

3. "Default value" means the function parameter will restore to the default value during default parameters restoring. But the detected parameter or recorded value will not be restored.

4. For a better parameter protection, the inverter provides password protection to the parameters and only factory and administrator can modify the function codes. After setting the user password (F05.03 is non-zero) and press the **ESC** key to enter into the parameter editing state, the system goes into user password verification and displays "0. 0. 0. 0. 0.". You can enter only by inputting the correct user password. For the factory setting parameter zone, only factory can enter. (Remind that the users cannot modify the factory parameters by themselves; otherwise, if the parameter setting is incorrect, damage to the system may occur). If the password protection is unlocked, the user can modify the password freely and the user password will be subject to the last one. When F05.03=0, the user password is disabled.

5. When modifying the function parameters through 485 communication, the function of user password follows the above rules.

Table 4-1 Parameter table

Function code	Name	Detailed instruction of parameters	Default value	Attribution
F00 Group Basic function				

Function code	Name	Detailed instruction of parameters	Default value	Attribution
F00.00	Motor control mode	0:speed sensorless vector control 1:reserved 2:V/F control	2	☆
F00.01	Run command channel	0: keypad run command channel (LED off) 1: terminal running command channel (LED on) 2: 485 run command channel (LED flickering)	0	○
F00.02	Main frequency source X	0:digital setting (pre-set frequency F00.09,UP/DOWN change, no power down memory) 1:digital setting (pre-set frequency F00.09,UP/DOWN change, with power down memory) 2:A11 3:A12 4:keypad potentiometer AI0 5:high speed pulse input (DI5) 6:multi-step speed 7:simple PLC 8:PID 9:485 communication	0	☆
F00.03	Auxiliary frequency source Y	Same as F00.02main frequency	0	☆
F00.04	Reference object of frequency source	Y0: relative to the max. frequency 1: relative to frequency source X	0	○
F00.05	Frequency source selection	Unit: frequency source selection 0: main 1: main and auxiliary operation (decided by ten) 2: main<--> auxiliary 3: main<-->main and auxiliary operation 4:auxiliary<-->main and auxiliary operation Ten: main and auxiliary operation relationship 0:main + auxiliary 1:main- auxiliary 2:max 3: min	00	○
F00.06	Max. frequency	50.00Hz~500.00Hz	50.00	☆
F00.07	Upper limit frequency	F00.08~F00.06 (Max. frequency)	50.00	○
F00.08	Lower limit frequency	0.00Hz~F00.07 (upper limit of running frequency)	0.00	○
F00.09	Frequency pre-setting	0.00Hz~F00.06 (Max. frequency)	50.00	○
F00.10	Run direction	0: positive 1: reverse	0	○
F00.11	Carrier frequency	0.5kHz~16.0kHz	6.0	○
F00.12	Carrier frequency adjusted according to temperature	0:no 1:yes	1	○
F00.13	Motor selection	0:motor 1	0	☆

Function code	Name	Detailed instruction of parameters	Default value	Attribution
		1: motor 2		
F00.14	ACC time 1	0.00s~650.00s (F00.16=2) 0.0s~6500.0s (F00.16=1) 0s~65000s (F00.16=0)	20.0	○
F00.15	DEC time 1	0.00s~650.00s (F00.16=2) 0.0s~6500.0s (F00.16=1) 0s~65000s (F00.16=0)	20.0	○
F00.16	Unit of ACC/DEC time	0:1s 1:0.1s 2:0.01s	1	☆
F00.17	Auxiliary frequency source Y range	0%~150%	100	○
F00.18	Upper limit frequency source	0:F00.07set 1:AI1 2:AI2 3:keypad potentiometerAI0 4:high speed pulse input 5:485 communication	0	☆
F00.19	Upper limit frequency offset	0.00Hz~max frequencyF00.06	0.00	○
F00.20	Superimposed auxiliary frequency source offset	0.00Hz~max frequencyF00.06	0.00	○
F00.21	Decimal point of frequency instruction	1:0.1Hz 2:0.01Hz	2	☆
F00.22	Digital setting frequency memory selection	0: save memory 1: not save memory	0	○
F00.23	Basis frequency of ACC/DEC time	0:Max frequency (F00.06) 1:setting frequency 2:100Hz	0	☆
F00.24	Basis frequency of running frequencyUP/DOWN	0:running frequency 1:setting frequency	0	☆
F00.25	Command source binding frequency source	Unit: keypad command, binding frequency source selection 0: no binding 1: digital setting frequency 2:AI1 3:AI2 4:keypad potentiometer AI0 5:high speed pulse input (DI5) 6:multi-step speed 7:simple PLC 8:PID 9:485 communication Ten: Terminal command binding frequency source selection Hundreds:communication command binding frequency source selection	000	○
F00.26	Serial communication protocol selection	0:Modbus-RTU protocol 1:reserved	0	☆
F01 Group Motor 1 parameters				
F01.00	G/Ptype	0:G type 1:P type	0	☆
F01.01	Motor type	0: normal asynchronous motor	0	☆

Function code	Name	Detailed instruction of parameters	Default value	Attribution
		1: change frequency asynchronous motor		
F01.02	Rated power of asynchronous motor	Depend on model		☆
F01.03	Rated frequency of asynchronous motor	0.01Hz~ (Max. frequency)F00.06	50.00	☆
F01.04	Rated speed of asynchronous motor	1rpm~65535rpm	1460	☆
F01.05	Rated voltage of asynchronous motor	1V~2000V	380	☆
F01.06	Rated current of asynchronous motor	0.01A~655.35A	9.00	☆
F01.07	Stator resistance of asynchronous motor	0.001Ω~65.535Ω	1.204	☆
F01.08	Rotor resistance of asynchronous motor	0.001Ω~65.535Ω	0.908	☆
F01.09	Inductance of asynchronous motor	0.01mH~655.35mH	5.28	☆
F01.10	Mutual inductance of asynchronous motor	0.1mH~6553.5mH	158.6	☆
F01.11	Non-load current of asynchronous motor	0.01A~F01.03	4.24	☆
F01.12	Motor parameters autotuning	0: no actuation 1: dynamic autotuning (no load) 2: static autotuning 1 (with load) 3: : static autotuning 2	0	☆
F01.13	Encoder pulse quantity		1024	☆
F01.14	Encoder type	0: ABZ incremental encoder 1: UVW incremental encoder 2: Resolver encoder 3: Sin-Cos encoder 4: Line-saving UVW encoder	0	☆
F01.15	Speed feedback PG selection	0:local PG 1:expand PG 2:HDI high speed pulse input	0	☆
F01.16	ABZ encoder AB phase sequence	0:positive 1:negative	0	☆
F01.17	encoder install position angle	0.0 ~ 359.9°	0.0	☆
F01.18	UVW signal phase sequence	0:positive 1:negative	0	☆
F01.19	UVW signal 0 position angle	0.0 ~ 359.9°	0.0	☆
F01.20	Resolver pole pair number	1~65535	1	☆
F01.21	reserve	reserve	0	☆
F01.22	speed feedback PG disconnection detection time	0.0 : no action 0.1s ~ 10.0s	0.0	☆
F01.23 ~F01.3 8	reserve	reserve	0	●

Function code	Name	Detailed instruction of parameters	Default value	Attribution
F02 Group Start and stop control				
F02.00	Start mode	0: start at the starting frequency 1: start after rotating speed tracking 2: Pre excitation	0	○
F02.01	Start delay time	0.0s~1000.0s	0.0	○
F02.02	Starting frequency	0.00Hz~10.00Hz	0.00	○
F02.03	Hold time of starting frequency	0.0s~100.0s	0.0	☆
F02.04	Start DC braking/Pre excitation current	0%~100%	0	☆
F02.05	Start DC braking/Pre excitation time	0.0s~100.0s	0.0	☆
F02.06	ACC and DEC mode	0: linear type 1: S curve A 2: S curve B	0	☆
F02.07	Terminal DI1 characteristic selection after power on	0: invalid 1:valid	0	☆
F02.08	Restart after power off	0: invalid 1:valid	0	☆
F02.09	Waiting time for restart	0.0s~100.0s	0.0	☆
F02.10	Stop mode	0: decelerate to stop 1: coast to stop	0	○
F02.11	Dead time of FWD/REV	0.0s~3000.0s	0.0	○
F02.12	Starting frequency before stop DC braking	0.00Hz~max frequency F00.06	0.00	○
F02.13	Waiting time before stop DC braking	0s~100.0s	0.0	○
F02.14	Stop DC braking current	0.0%~100%	0	○
F02.15	Stop DC braking time	0.0s~100.0s	0.0	○
F02.16	Braking use reate	0%~100%	100	○
F02.17	Delay time of dormancy	0.0~6500.0s	0.0	○
F02.18	Actuation when running frequency is less than lower limit frequency	0: run at lower limit frequency 1: stop 2: 0 speed run	0	○
F02.19	Delay time of dormancy wake up	0.0s~6500.0s	0.0	○
F02.20	Speed track mode	0:start from stop frequency 1:start from working frequency 2: start from max frequency	0	☆
F02.21	Quick or slow speed track	1~100	20	○
F02.22	Speed track KP	0~1000	500	○
F02.23	Speed track KI	0~1000	800	○
F02.24	Speed track current	30%~200%	100	☆
F02.25	Speed track low limit	10~100%	30	☆
F02.26	Speed track voltage rise time	5~30	11	☆
F02.27	Demagnetizing time	0.00~5.00s	1.00	☆
F02.28	S curve first phase time rate	0.0%~(100.0%-F06.29)	30.0	☆
F02.29	S curve final phase time rate	0.0%~(100.0%-F06.28)	30.0	☆

Function code	Name	Detailed instruction of parameters	Default value	Attribution
F03 Group V/F control				
F03.00	V/F curve	0: straight line V/F curve 1: multi-dots V/F curve 2: square V/F curve 3: 1.2 th V/F curve 4: 1.4 th V/F curve 6: 1.6 th V/F curve 8: 1.8 th V/F curve 10: VF total separate mode 11: VF half separate mode	0	☆
F03.01	Torque compensation	0.0%:automatic 0.1%~30.0% VF separate invalid	1.0	○
F03.02	Torque compensation cut-off frequency	0.00Hz~max frequency F00.06	50.00	☆
F03.03	V/F frequency 1	0.00Hz~F03.05	0.00	☆
F03.04	V/F voltage 1	0.0%~100.0%	0.0	☆
F03.05	V/F frequency 2	F03.03~F03.07	0.00	☆
F03.06	V/F voltage 2	0.0%~100.0%	0.0	☆
F03.07	V/F frequency 3	F03.05~motor rated voltage (F01.03)	0.00	☆
F03.08	V/F voltage 3	0.0%~100.0%	0.0	☆
F03.09	Slip compensation gain	0.0%~200.0%	0.0	○
F03.10	VF over excitation gain	0~200	64	○
F03.11	Oscillation suppression gain	0~100	0	○
F03.12	Oscillation suppression gain mode	0~4	3	☆
F03.13	VF separate voltage source	0:digital setting (F03.14) 1:A11 2:A12 3:reserve 4:HDI high speed pulse setting 5:multi-step 6:simple PLC 7:PID 8:communication setting 100.0% refer to motor rated voltage	0	○
F03.14	VF separate voltage source setting	0V~motor rated voltage F01.05	0	○
F03.15	VF separate voltage ACC time	0.0s~1000.0s It means time from 0v to motor rated voltage	0.0	○
F03.16	VF separate voltage DEC time	0.0s~1000.0s It means time from motor rated voltage to 0v	0.0	○
F03.17	VF separate stop model	0:frequency/voltage reduce to 0 separately 1:voltage reduce to 0, than frequency reduce	0	☆
F03.18	Current compensation coefficient of double speed over-current stall action	50~200%	130	☆
F03.19	Overvoltage stall action voltage	200.0v~2000.0v set according to model	1	☆

Function code	Name	Detailed instruction of parameters	Default value	Attribution
		220V:380V 380V:760V		
F03.20	Overvoltage stall enable	0:invalid 1:valid	20	○
F03.21	Current compensation coefficient of double speed over-current stall action	50~200%	50	☆
F03.22	Overvoltage stall action voltage	200.0v~2000.0v set according to model 220V:380V 380V:760V	760.0	☆
F03.23	Overvoltage stall enable	0:invalid 1:valid	1	☆
F03.24	Overvoltage stall suppression frequency gain	0~100	30	○
F03.25	Overvoltage stall suppression voltage gain	0~100	30	○
F03.26	Overvoltage stall max frequency rise limit	0~50Hz	5	☆
F03.27	Slip compensation time constant	0.1~10.0s	0.5	○
F03.28	Automatic increase frequency enable	0: invalid 1: valid	0	☆
F03.29	Min electric torque current	10%~100%	50	☆
F03.30	Max power torque current	10%~100%	20	☆
F03.31	Automatic increase frequency KP	0~100	50	☆
F03.32	Automatic increase frequency KI	0~100	50	☆
F03.33	On line torque compensation gain	80%~150%	100	☆
F04 Group Motor 1 Vector control				
F04.00	Speed loop proportional gain 1	1~100	30	○
F04.01	Integral time of speed loop 1	0.01s~10.00s	0.50	○
F04.02	Switch frequency1	0.00~F04.05	5.00	○
F04.03	Speed loop proportional gain 2	1~100	20	○
F04.04	Integral time of speed loop 2	0.01s~10.00s	1.00	○
F04.05	Switch frequency2	F02.02~max frequency F00.06	10.00	○
F04.06	Slip gain of vector control	50%~200%	100	○
F04.07	SVC Speed feedback filtering time	0.000s~1.000s	0.050	○
F04.08	Overexcitation gain of vector control	0~200	64	○
F04.09	Speed control (drive) torque max limit digital setting	0.0%~200.0%	150.0	○

Function code	Name	Detailed instruction of parameters	Default value	Attribution
F04.10	Speed control (drive) torque max limit source	0:F04.09 set 1:A11 2:A12 3:reserve 4:HDI high speed pulse setting 5:communication setting 6:min (A11, A12) 7:MAX (A11,A12) 1-7 Full scale corresponding to F04.09	0	○
F04.11	Speed control (braking) torque max limit source	0:F04.12 set 1:A11 2:A12 3:reserve 4:HDI high speed pulse setting 5:communication setting 6:min (A11, A12) 7:MAX (A11,A12) 1-7 Full scale corresponding to F04.12	0	○
F04.12	Speed control (braking) torque max limit digital setting	0.0%~200.0%	150.0	○
F04.13	Proportional gain of excitation regulation	0~60000	2000	○
F04.14	Integral gain of excitation regulation	0~60000	1300	○
F04.15	Proportional gain of torque regulation	0~60000	2000	○
F04.16	Integral gain of torque regulation	0~60000	1300	○
F04.17	Integral attribute of speed loop	Unit place:integral separation 0: Integral always valid 1: speed loop integral separation	0	○
F04.18	Vector control mode weak magnetic mode selection	0:no weak magnetic 1:direct calculate 2:Automatic adjust	0	○
F04.19	Over modulation enable selection	0:forbid 1:enable	0	○
F04.20	Maximum output voltage coefficient	100%~110%	105	☆
F04.21	Maximum torque coefficient in weak magnetic region	50%~200%	100	○
F04.22	Selection of generation (braking) torque enabling under speed model	0:disable 1:enable	0	○
F05 Group Keypad and display				
F05.00	reserve	0~65535	0	●
F05.01	Parameter initialization	0: no actuation 01: recover default value, not include motor parameters 02: clear fault records 04:backup user parameters	0	☆

Function code	Name	Detailed instruction of parameters	Default value	Attribution
		501: recover user parameters		
F05.02	reserved	0~65535	0	●
F05.03	User password	0~65535	0	○
F05.04	Functions of MF key	0: MF invalid 1:switch between keypad command and remote command 2:FWD/REV switch 3:FWD jog 4: REV jog	0	☆
F05.05	Stop function of STOP/RERST key	0: only valid for keypad control 1: valid for all control modes	1	○
F05.06	Rotating speed display correction	0.0001~6.5000	1.0000	○
F05.07	Linear speed display correction	0.0001~6.5000	1.0000	○
F05.08	Displayed parameters 1 when running	0000~FFFF BIT00: running frequency (Hz) BIT01: set frequency (Hz) BIT02: bus voltage (V on) BIT03: output voltage (V) BIT04: output current (A) BIT05: output power (kW) BIT06: output torque (%) BIT07: DI output state BIT08: DO output state BIT09: AI1 voltage (v) BIT10: AI2 voltage (v) BIT11: reserve BIT12: Count value BIT13: Length value Pulse HDI frequency BIT14:load speed display BIT15:PID set	0x001F	○
F05.09	Displayed parameters 2 when running	0000~FFFF BIT00: PID feedback BIT01: PLC stage BIT02: high speed pulse input pulse frequency (kHz) BIT03: running frequency 2 (Hz) BIT04:Remaining run time BIT05: AI1 voltage before correction BIT06: AI2 voltage before correction BIT07: reserve BIT08: linear speed BIT09: current power on time BIT10: current running time Bit11:high speed pulse input pulse frequency, unit:1Hz Bit12: communication set Bit13: encoder feedback speed Bit14: main frequency X display Bit15auxiliary frequency Y display	0x0000	○
F05.10	LED display at stop	0000~FFFF Bit00: set frequency (Hz) Bit01: bus voltage (V)	0x0033	○

Function code	Name	Detailed instruction of parameters	Default value	Attribution
		Bit02:DI input state Bit03:DO output state Bit04: AI1 voltage (v) Bit05: AI2 voltage (v) Bit06:reserve BIT07: Count value BIT08: Length value Bit09:PLC stage Bit10: load speed Bit11:PID set Bit12: high speed pulse input pulse frequency (kHz)		
F05.11	Software version 1	v0.0x	0.00	●
F05.12	Software version 2	v0.0x	0.00	●
F05.13	Product name	CT100G	0	●
F05.14	Inverter module radiator temperature	0.0℃～100.0℃	0	●
F05.15	Cumulative running time	0h～65535h	0	●
F05.16	Load speed display decimal places	Unit place:B00.14 decimal places 0:0 1:1 2:2 3:3 Ten place:B00.19/B00.29 decimal places 1:1 2:2	21	○
F05.17	Cumulative power on time	0h～65535h	0	●
F05.18	Cumulative power consumption	0～65535°	0	●
F06 Group Input terminals				
F06.00	Functions of DI1 terminal	0: invalid	1	☆
F06.01	Functions of DI2 terminal	1: forward running 2: reverse running	4	☆
F06.02	Functions of DI3 terminal	3: Three line operation control	9	☆
F06.03	Functions of DI4 terminal	4: forward jogging	12	☆
F06.04	Functions of DI5 terminal	5: reverse jogging 6:terminal UP	13	☆
F06.05	Functions of DI6 terminal	7:terminal DOWN	0	☆
F06.06	Functions of DI7 terminal	8: coast to stop	0	☆
F06.07	reserved	9: fault reset 10: run pause	0	☆
F06.08	reserved	11: external fault constant open input 12: multi-step speed terminal 1 13: multi-step speed terminal 2 14: multi-step speed terminal 3 15: multi-step speed terminal 4 16: ACC/DEC selection 1 17: ACC/DEC selection 2 18: frequency source switch 19: UP/DOWN setting clear (terminal, keypad) 20: running command switch 21: ACC/DEC forbid 22: PID pause 23: PLC reset 24: wobble pause	0	☆

Function code	Name	Detailed instruction of parameters	Default value	Attribution
		25: counter input 26: counter reset 27: length count input 28: length reset 29: torque control forbid 30: high speed pulse (pulse) frequency input (only valid to DI5) 31:reserved 32:Immediate DC braking 33:external fault constant open input 34: frequency set being valid terminal (if terminal set as this function. The terminal will be used to control what time the frequency change setting start to work) 35:negative PID direction 36: external stop terminal 1 (under keypad control mode, use this terminal to stop as the STOP key on keypad 37: control command switch terminals 2 (switch between terminal control and communication control) 38:PID integral pause 39:X setting and pre-setting switch 40:Y setting and pre-setting switch 41:motor selection terminal 1 42:reserve 43:PID parameter switch terminal 44: user define fault 1 45: user define fault 2 46:speed control/ torque control switch 47: emergency stop 48: external stop terminal 2 (under any control mode, this terminal can be used to stop as DEC time 4 49:DEC DC braking 50:this running time to 0 51:two/three wire mode switch 52: forbid REV 53~59:reserved		
F06.09	reserve		0	☆
F06.10	DI filter time	0.000s~1.000s	0.010	○
F06.11	Terminal control running mode	0: two-wire control mode 1 1: two-wire control mode 2 2: three-wire control mode 1 3: three-wire control mode 2	0	☆
F06.12	Terminal UP/DOWN change rate every s	0.001Hz/s~65.535Hz/s	1.000	○
F06.13	Curve 1 minimum input	0.00V~F06.15	0.00	○
F06.14	Curve 1 minimum input corresponding setting	-100.0%~100.0%	0.0	○
F06.15	Curve 1 maximum input	F06.13~10.00V	10.00	○
F06.16	Curve 1 maximum input corresponding setting	-100.0%~100.0%	100.0	○
F06.17	AI1 filter time	0.00s~10.00s	0.10	○

Function code	Name	Detailed instruction of parameters	Default value	Attribution
F06.18	Curve 2 minimum input	0.00V~F06.20	0.00	○
F06.19	Curve2 minimum input corresponding setting	-100.0%~100.0%	0.0	○
F06.20	Curve 2 maximum input	F06.18~10.00V	10.00	○
F06.21	Curve 2 maximum input corresponding setting	-100.0%~100.0%	100.0	○
F06.22	AI2filter time	0.00s~10.00s	0.10	○
F06.23	Curve 3 minimum input	-10,00V~F06.25	-10.00	○
F06.24	Curve 3 minimum input corresponding setting	-100.0%~100.0%	-100.0	○
F06.25	Curve 3 maximum input	F06.23~10.00V	10.00	○
F06.26	Curve 3 maximum input corresponding setting	-100.0%~100.0%	100.0	○
F06.27	reserve	0.00s~10.00s	0.10	○
F06.28	PULSE minimum input	0.00kHz~F06.30	0.00	○
F06.29	PULSE minimum input corresponding setting	-100.0%~100.0%	0.0	○
F06.30	PULSE maximum input	F06.28~100.00kHz	50.00	○
F06.31	PULSE maximum input setting	-100.0%~100.0%	100.0	○
F06.32	PULSE filt time	0.00s~10.00s	0.10	○
F06.33	AI setting curve selection	Unit place:AI1curve selection 1:curve1 (2point, referF06.13~F06.16) 2:curve2 (2point, referF06.18~F06.21) 3:curve3 (2point, referF06.23~F06.26) 4:curve4 (4point, referA06.00~A06.07) 5:curve5 (4point, referA06.08~A06.15) Ten place:AI2curveselection, same as AI1 Hundred place: reserve	321	○
F06.34	AI lower than minimum input setting selection	Unit place:AI1lower than minimum input setting selection 0: set minimum input correspondingly 1:0.0% Ten place:AI2lower than minimum input setting selection, same as AI1 Hundred place:reserve	000	○
F06.35	DI1delay time	0.0s~3600.0s	0	○
F06.36	DI2delay time	0.0s~3600.0s	0	○
F06.37	DI3delay time	0.0s~3600.0s	0	○
F06.38	DI1-DI5input terminal valid selection	0:high level 1:low level Unit place:DI1 Ten place:DI2 hundred place:DI3 Thousand place:DI4 Ten thousand place:DI5	00000	☆
F06.39	DI6-DI7input terminal valid selection	0:high level 1:low level Unit place:DI6 Ten place:DI7 hundred place:reserve Thousand place:DI4reserve	00000	☆

Function code	Name	Detailed instruction of parameters	Default value	Attribution
		Ten thousand place:reserve		
F07 Group Output terminals				
F07.00	HDO output mode	0:pulse output 1:switch output	0	○
F07.01	HDO switch output selection	0: no output	0	○
F07.02	Relay T1 output selection	1: running	2	○
F07.03	Relay T2 output selection	2: fault output	0	○
		3: frequency level detection FDT1 output 4: frequency arrival 5: zero speed running 1 (no output at stop) 6: motor over load pre-alarm 7: inverter over load pre-alarm 8: set count value arrival 9: specified count value arrival 10:length arrival 11:simple PLC cycle is completed 12:running time arrival 13: frequency is limited 14: torque is limited 15: ready to run 16:AI1>AI2 17:upper limit frequency arrival 18:lower limit frequency arrival (related to running) 19:under voltage state output 20: communication set 21:location finished (reserved) 22:location approach (reserved)		
F07.04	D0 output selection	23:zero speed running 2 (output at stop) 24:power on time arrive 25:frequency level detection FDT2 output 26:frequency arrive 1 output 27: frequency arrive 2 output 28: current arrive 1 output 29: current arrive 2 output 30: time arrive output 31: AI1 input out of limit 32: loss load 33: REV running 34: 0 current state 35: module temperature arrive 36: output current over limit 37: lower frequency arrive (not related to running) 38: fault output (all faults) 39: motor over heat pre-alarm 40: current running time arrive 41: fault output (free stop faults and not output under voltage)	1	○
F07.05	reserve	reserve	4	○
F07.06	HDO pulse output selection	0: running frequency	0	○

Function code	Name	Detailed instruction of parameters	Default value	Attribution
F07.07	AO1 output selection	1: set frequency	0	○
F07.08	AO2 output selection	2: output current 3: output torque 4: output power 5: output voltage 6: high speed pulse output (100.0% corresponding to 100.0kHz) 7: AI1 8: AI2 9: reserve 10: length 11: count value 12: communication set 13: motor speed 14: output current (100.0% corresponding to 1000.0A) 15: output voltage (100.0% corresponding to 1000.0V) 16: motor output torque (true value, percentage of rated current relative to motor) 17: inverter output torque (true value, percentage of rated current relative to inverter)	1	○
F07.09	HDO pulse output max frequency	0.01kHz~100.00kHz	50.00	○
F07.10	AO1 bias coefficient	-100.0%~100.0%	0.0	○
F07.11	AO1 gain	-10.00~10.00	1.00	○
F07.12	AO2 bias coefficient	-100.0%~100.0%	0.0	○
F07.13	AO2 gain	-10.00~10.00	1.00	○
F07.14	HDO switch output delay time	0.0s~3600.0s	0.0	○
F07.15	Relay 1 output delay time	0.0s~3600.0s	0.0	○
F07.16	Relay 2 output delay time	0.0s~3600.0s	0.0	○
F07.17	DO output delay time	0.0s~3600.0s	0.0	○
F07.18	reserve			
F07.19	DO output terminal valid state selection	0: positive logic 1: negative logic unit place: HDO ten place: relay 1 hundred place: relay 2 thousand place: DO ten thousand place: reserve	00000	○
F08 Group Fault and protection				
F08.00	Motor overload protection selection	0: permit 1: forbid	1	○
F08.01	Motor overload protection gain	0.20~10.00	1.00	○
F08.02	Motor overload pre-alarm coefficient	50%~100%	80	○
F08.03	Motor overload pre-alarm detection time	0.20s~10.00s	1.00	○

Function code	Name	Detailed instruction of parameters	Default value	Attribution
F08.04	Motor overload pre-alarm act selection	0: no detection 1: overload warning is valid in running, continue to run 2: overload warning is valid in running, alarm (OL3) and stop 3: overload warning is valid in constant speed running, continue to run after detection 4: overload warning is valid in constant speed running, alarm (OL3) and stop after detection	1	○
F08.05	Over-voltage stall gain	0~100	0	○
F08.06	Over-voltage stall protection voltage	200.0~2000.0v set according to different models 220V:380V 380V:760V	760.0	☆
F08.07	Over-current stall gain	0~100	20	○
F08.08	Over-current stall protection current	100%~200%	150	☆
F08.09	Instant stop not stop gain Kp	0~100	40	○
F08.10	Instant stop not stop Integral coefficient Ki	0~100	30	○
F08.11	Instant stop not stop act DEC time	0.0~300.0s	20.0	☆
F08.12	Input phase loss / contactor protection	Unit place: input phase loss protection selection Ten place: contactor protection selection 0: disabled 1: enabled	01	○
F08.13	Output phase loss protection selection	0: disabled 1: enabled	1	○
F08.14	Automatic reset times	0~20	0	○
F08.15	Automatic reset interval	0.1s~100.0s	1.0	○
F08.16	First fault type	0: no fault 1: inverter unit U phase protection (E.oUt1) 2: inverter unit V phase protection (E.oUt2) 3: inverter unit W phase protection (E.oUt3) 4: ACC overcurrent (E.oC1) 5: DEC overcurrent (E.oC2) 6: constant speed overcurrent (E.oC3) 7: ACC overvoltage (E.oU1) 8: DEC overvoltage (E.oU2) 9: constant speed overvoltage (E.oU3) 10: bus undervoltage fault (E.Lv) 11: motor overload (E.oL1) 12: inverter overload (E.oL2) 13: input side phase loss (E.ILF) 14: output side phase loss (E.oLF) 15: rectifier radiator overheating (E.oH1)	0	●

Function code	Name	Detailed instruction of parameters	Default value	Attribution
		16: inverter radiator overheating (E.oH2) 17: external fault (E.EF) 18: communication failure (E.485) 19: current detection fault (E.ItE) 20: motor parameter learning fault(E.AUt) 21:EEFROM operation fault (E.EEP) 22: PID disconnection fault (E.PIDE) 23: (braking unit fault (E.bC) 24:run time arrival (E.END) 25:electric overload (E.oL3) 26:keypad communication fault (E.FCE) 27: parameter upload fault (E.UFE) 28: parameter download fault (E.dNE) 29:reserved 30:reserved 31:reserved 32:earth fault 1 (E.EAH1) 33:earth fault 2 (E.EAH2) 34:speed bias fault (E.dEU) 35:mis-adjust fault (E.Sto) 36: under load fault (E.LL) 37:reserved 38:Buffer resistance overload fault (E.BoL) 39:contactor fault (E.CEr) 40:quick limit third fault (E.CBC) 41:switch motor while running (E.CrP) 42:user define fault 1 (E.uD1) 43:user difin fault 2 (E.uD2) 44:power on time arrive (E.PTo)		
F08.17	Second fault type		0	●
F08.18	Third fault type (latest fault)		0	●
F08.19	Frequency at third fault		0.00	●
F08.20	Current at third fault		0.00	●
F08.21	Bus voltage at third fault		0.0	●
F08.22	Input terminal status at third fault		0	●
F08.23	Output terminal status at third fault		0	●
F08.24	Inverter status at third fault		0	●
F08.25	Third fault time (count from latest power on)		0	●
F08.26	Third fault time (count from latest start running)		0.0	●

Function code	Name	Detailed instruction of parameters	Default value	Attribution
F08.27	Frequency at second fault		0.00	●
F08.28	Current at second fault		0.00	●
F08.29	Bus voltage at second fault		0.0	●
F08.30	Input terminal status at second fault		0	●
F08.31	Output terminal status at second fault		0	●
F08.32	Inverter status at second fault		0	●
F08.33	Second fault time (count from latest power on)		0	●
F08.34	Second fault time (count from latest start running)		0.0	●
F08.35	Frequency at first fault		0.00	●
F08.36	Current at first fault		0.00	●
F08.37	Bus voltage at first fault		0.0	●
F08.38	Input terminal status at first fault		0	●
F08.39	Output terminal status at first fault		0	●
F08.40	Inverter status at first fault		0	●
F08.41	First fault time (count from latest power on)		0	●
F08.42	First fault time (count from latest start running)		0.0	●
F08.43	Power one earth protection selection	0:invalid 1:valid	1	○
F08.44	Braking start voltage	200.0~2000.0v set according different models 220V:360V 380V:690V	690.0	○
F08.45	DO act selection while fault automatic reset period	0:not act 1:act	0	○
F08.46	Fault protection act selection 1	Unit place: motor over load (E.oL1) 0:free stop 1:stop as stop mode 2:continue running Ten place: input phase loss (E.ILF) hundred place: output phase loss (E.oLF) Thousand: external fault (E.EF) Ten thousand: communication failure (E.485)	00000	○
F08.47	Fault protection act selection 2	Unit place: encoder fault (E.PGL) 0:free stop Ten place:reserved 0:free stop 1:stop as stop mode Ten place:reserved Thousand place:reserved Ten thousand place:running time arrive (E.END)	00000	○
F08.48	Fault protection act selection 3	Unit place: user define fault 1 (E.uD1) 0:free stop 1:stop as stop mode	00000	○

Function code	Name	Detailed instruction of parameters	Default value	Attribution
		2:continue running Ten place: user define fault 2 (E.uD2) 0:free stop 1:stop as stop mode 2:continue running ten place:power on time arrive (E.PTo) 0:free stop 1:stop as stop mode 2:continue running Thousand place:reserved 0:free stop 1:DEC stop 2: DEC to 7% of motor rated frequency and run. Automatic back to set frequency if not loss load Ten thousand place: PID feedback disconnect fault (E.PIdE) 0:free stop 1:stop as stop mode 2:continue running		
F08.49	Fault protection act selection 4	Unit place:too big speed bias (E.dEU) 0:free stop 1:stop as stop mode 2:continue running ten place:reserved hundred place:reserved	000	○
F08.50	reserved			
F08.51	Continue running (while fault) frequency selection	0:running as current frequency 1:running as set frequency 2:running as upper limit frequency 3:running as lower limit 4:running as abnormal standby frequency	0	○
F08.52	Abnormal standby frequency setting	0.0%~100.0% (current aim frequency)	100	○
F08.53	Motor temperature sensor types	0:no temperature sensor 1:PT100 2:PT1000	0	○
F08.54	Motor over heat protection value	0℃~200℃	110	○
F08.55	Motor over heat pre alarm value	0℃~200℃	90	○
F08.56	Instant stop not stop act selection	0:invalid 1:DEC 2:DEC to stop	1	☆
F08.57	Judging voltage for suspended stop instant stop act	80.0%~100.0%	85.0	☆
F08.58	Judging time for instant stop not stop voltage rise	0.0s~100.0s	0.5	☆
F08.59	Judging voltage for instant stop not stop act	60.0%~100.0% (standard bus voltage)	80.0	○
F08.60	Loss load protection selection	0:invalid 1:valid	0	○
F08.61	Detection lever for loss load	0.0~100.0%	10.0	○
F08.62	Detection time for loss load	0.0~60.0s	1.0	○
F08.63	reserved	0~65536	0	●

Function code	Name	Detailed instruction of parameters	Default value	Attribution
F08.64	Over speed detection value	0.0%~50.0% (max frequency)	20.0	○
F08.65	Over speed detection time	0.0s:no detection 0.1~60.0s	1.0	○
F08.66	Detection value for too big speed bias	0.0%~50.0% (max frequency)	20.0	○
F08.67	Detection time for too big speed bias	0.0s: no detection 0.1~60.0s	5.0	○
F09 Group PID function				
F09.00	PID reference channel	0: F09.01 set 1:AI1 2:AI2 3:reserve 4: High speed pulse set 5:communication set 6:multi step speed set	0	○
F09.01	PID digital give	0.0%~100.0%	50.0	○
F09.02	PID feedback channel	0:AI1 1:AI2 2:reserve 3:AI1-AI2 4:high speed pulse 5:communication 6:AI1+AI2 7:MAX (AI1 , AI2) 8:min (AI1 , AI2)	0	○
F09.03	PID direction	0: positive 1: negative	0	○
F09.04	PID feedback range	0~65535	1000	○
F09.05	PID REV stop frequency	0.00Hz~max frequency F00.06	2.00	○
F09.06	Proportional gain P1	0.0~100.0	20.0	○
F09.07	Integral time I1	0.01s~10.00s	2.00	○
F09.08	Differential time D1	0.000s~10.000s	0.000	○
F09.09	reserved	0~65535	0	●
F09.10	PID control deviation limit	0.0%~100.0%	0.0	○
F09.11	Feedback loss detection value	0.0%: not judge feedback loss 0.1%~100.0%	0.0	○
F09.12	Feedback loss detection time	0.0s~20.0s	0.0	○
F09.13	PID Differential limit	0.00%~100.00%	0.10	○
F09.14	PIDgive change time	0.00~650.00s	0.00	○
F09.15	PID feedback filter time	0.00~60.00s	0.00	○
F09.16	PID output filter time	0.00~60.00s	0.00	○
F09.17	Proportional gain P2	0.0~100.0	20.0	○
F09.18	Integral time I2	0.01s~10.00s	2.00	○
F09.19	Differential time D2	0.000s~10.000s	0.000	○
F09.20	PID parameter change term	0:not change 1:DI terminal 2:Automatic change according to bias 3: Automatic change running frequency	0	○
F09.21	PID parameter change bias 1	0.0%~F10.22	20.0	○

Function code	Name	Detailed instruction of parameters	Default value	Attribution
F09.22	PIDparameter change bias 2	F10.21~100.0%	80.0	○
F09.23	PID initial value	0.0%~100.0%	0.0	○
F09.24	PID initial value keep time	0.00~650.00	0.00	○
F09.25	FWD max bias of two output	0.00~100.00%	1.00	○
F09.26	REV max bias of two output	0.00%~100.00%	1.00	○
F09.27	PID Integral attribute	Unit place: integral attribute 0: invalid 1: valid Ten place: output arrive limit, stop integral or not 0:not stop 1:stop	00	○
F09.28	PID stop calculation	0: calculate at stop 1: calculate at stop	0	○
F10 Group Wobble, step length and count value				
F10.00	Wobble set mode	0:Corresponding to centre frequency 1:Corresponding to maximum frequency	0	○
F10.01	Wobble range	0.0%~100.0%	0.0	○
F10.02	Saltation frequency amplitude	0.0%~50.0%	0.0	○
F10.03	Wobble cycle	0.1s~3000.0s	10.0	○
F10.04	Wobble triangular wave rise time	0.1%~100.0%	50.0	○
F10.05	Set length	0m~65535m	1000	○
F10.06	Actual length	0m~65535m	0	○
F10.07	Pulse per meter, unit:0.1	0.1~6553.5	100.0	○
F10.08	Set count value	1~65535	1000	○
F10.09	Designated count value	1~65535	1000	○
F11 Group Multi-step speed and PLC				
F11.00	Multi-step speed command 0	-100.0%~100.0% (100.0% corresponding to maximum frequency F00.06)	0	○
F11.01	Multi-step speed command 1	-100.0%~100.0% (100.0% of max frequency F00.06)	0	○
F11.02	Multi-step speed command 2	-100.0%~100.0% (100.0% of max frequency F00.06)	0	○
F11.03	Multi-step speed command 3	-100.0%~100.0% (100.0% of max frequency F00.06)	0	○
F11.04	Multi-step speed command 4	-100.0%~100.0% (100.0% of max frequency F00.06)	0	○
F11.05	Multi-step speed command 5	-100.0%~100.0% (100.0% of max frequency F00.06)	0	○
F11.06	Multi-step speed command 6	-100.0%~100.0% (100.0% of max frequency F00.06)	0	○
F11.07	Multi-step speed command 7	-100.0%~100.0% (100.0% of max frequency F00.06)	0	○
F11.08	Multi-step speed command 8	-100.0%~100.0% (100.0% of max frequency F00.06)	0	○
F11.09	Multi-step speed command 9	-100.0%~100.0%	0	○

Function code	Name	Detailed instruction of parameters	Default value	Attribution
		(100.0% of max frequency F00.06)		
F11.10	Multi-step speed command 10	-100.0%~100.0% (100.0% of max frequency F00.06)	0	○
F11.11	Multi-step speed command 11	-100.0%~100.0% (100.0% of max frequency F00.06)	0	○
F11.12	Multi-step speed command 12	-100.0%~100.0% (100.0% of max frequency F00.06)	0	○
F11.13	Multi-step speed command 13	-100.0%~100.0% (100.0% of max frequency F00.06)	0	○
F11.14	Multi-step speed command 14	-100.0%~100.0% (100.0% of max frequency F00.06)	0	○
F11.15	Multi-step speed command 15	-100.0%~100.0% (100.0% of max frequency F00.06)	0	○
F11.16	PLC work mode	0: stop after a single run 1: run at the final value after a single run 2: circulate to run	0	○
F11.17	PLC power failure memory	Unit place: 0:no power failure memory 1:with power failure memory Ten place: 0:no inverter stop memory 1:with inverter stop memory	0	○
F11.18	Step 0 running time	0.0s (h)~6553.5s (h)	0	○
F11.19	PLC step 0 ACC/DEC time selection	0~3	0	○
F11.20	Step 1 running time	0.0s (h)~6553.5s (h)	0	○
F11.21	PLC step 1 ACC/DEC time selection	0~3	0	○
F11.22	Step 2 running time	0.0s (h)~6553.5s (h)	0	○
F11.23	PLC step 2 ACC/DEC time selection	0~3	0	○
F11.24	Step 3 running time	0.0s (h)~6553.5s (h)	0	○
F11.25	PLC step 3 ACC/DEC time selection	0~3	0	○
F11.26	Step 4 running time	0.0s (h)~6553.5s (h)	0	○
F11.27	PLC step 4 ACC/DEC time selection	0~3	0	○
F11.28	Step 5 running time	0.0s (h)~6553.5s (h)	0	○
F11.29	PLC step 5 ACC/DEC time selection	0~3	0	○
F11.30	Step 6 running time	0.0s (h)~6553.5s (h)	0	○
F11.31	PLC step 6 ACC/DEC time selection	0~3	0	○
F11.32	Step 7 running time	0.0s (h)~6553.5s (h)	0	○
F11.33	PLC step 7 ACC/DEC time selection	0~3	0	○
F11.34	Step 8 running time	0.0s (h)~6553.5s (h)	0	○
F11.35	PLC step 8 ACC/DEC time selection	0~3	0	○

Function code	Name	Detailed instruction of parameters	Default value	Attribution
F11.36	Step 9 running time	0.0s (h)~6553.5s (h)	0	○
F11.37	PLC step 9 ACC/DEC time selection	0~3	0	○
F11.38	Step 10 running time	0.0s (h)~6553.5s (h)	0	○
F11.39	PLC step 10 ACC/DEC time selection	0~3	0	○
F11.40	Step 11 running time	0.0s (h)~6553.5s (h)	0	○
F11.41	PLC step 11 ACC/DEC time selection	0~3	0	○
F11.42	Step 12 running time	0.0s (h)~6553.5s (h)	0	○
F11.43	PLC step 12 ACC/DEC time selection	0~3	0	○
F11.44	Step 13 running time	0.0s (h)~6553.5s (h)	0	○
F11.45	PLC step 13 ACC/DEC time selection	0~3	0	○
F11.46	Step 14 running time	0.0s (h)~6553.5s (h)	0	○
F11.47	PLC step 14 ACC/DEC time selection	0~3	0	○
F11.48	Step 15 running time	0.0s (h)~6553.5s (h)	0	○
F11.49	PLC step 15 ACC/DEC time selection	0~3	0	○
F11.50	PLC running time unit	0:s 1:h	0	○
F11.51	Multi-step 0 give command mode	0:F11.00 1:A11 2:A12 3:reserve 4:high speed pulse 5:PID 6:F00.09 give, UP/DOWN can changeUP/DOWNmodify	0	○
F12 Group 485 communication				
F12.00	Local address	1~247, 0 broadcast address	1	○
F12.01	Baud rate	Unit place:MODBUS 0:300BPS 1:600BPS 2:1200BPS 3:2400BPS 4:4800BPS 5:9600BPS 6:19200BPS 7:38400BPS 8:57600BPS 9:115200BPS Ten place:reserved Hundred place:reserved Thousand place:reserved	5006	○
F12.02	Data check	0: no check (8-N-2) 1:even check (8-E-1) 2:odd check (8-O-1) 3:8-N-1	1	○

Function code	Name	Detailed instruction of parameters	Default value	Attribution
F12.03	Response delay	0ms~20ms	2	○
F12.04	Communication timeout detection time	0.0 (invalid) , 0.1s~60.0s	0.0	○
F12.05	Data transfer format selection	Unit position: not standard MODBUS-RTU protocol 0:not standard MODBUS-RTU protocol 1:standard MODBUS-RTU protocol Ten position:reserved	31	○
F12.06	Communication read current resolution	0:0.01A 1:0.1A	0	○
F12.07	reserve			
F13 Group Auxiliary function				
F13.00	Jogging frequency	0.00Hz~max frequencyF00.06	2.00	○
F13.01	Jogging running ACC time	0.0s~6500.0s	20.0	○
F13.02	Jogging running DEC time	0.0s~6500.0s	20.0	○
F13.03	ACC time 2	0.0s~6500.0s	20.0	○
F13.04	DEC time 2	0.0s~6500.0s	20.0	○
F13.05	ACC time 3	0.0s~6500.0s	20.0	○
F13.06	DEC time 3	0.0s~6500.0s	20.0	○
F13.07	ACC time 4	0.0s~6500.0s	20.0	○
F13.08	DEC time 4	0.0s~6500.0s	20.0	○
F13.09	Jump frequency 1	0.00Hz~Max. Frequency F00.06	0.00	○
F13.10	Jump frequency 2	0.00Hz~Max. Frequency F00.06	0.00	○
F13.11	Jump frequency range	0.00Hz~Max. Frequency F00.06	0.00	○
F13.12	REV control	0:permit REV 1: forbid REV	0	○
F13.13	Droop control	Slip when the torque current is equal to the rated current of the motor 0.00Hz~10.00Hz	0.00	○
F13.14	Set power on arrive time	0h~65535h	0	○
F13.15	Set running arrive time	0h~65535h	0	○
F13.16	Protection selection	0:not protect 1:protect	0	○
F13.17	Frequency detection value (FDT1)	0.00Hz~max frequency F00.06	50.00	○
F13.18	Frequency detection delay value (FDT1)	0.0%~100.0% (FDT1 level)	5.0	○
F13.19	Frequency arrival detection amplitude	0.0~100.0% (Max. frequency)	0.0	○
F13.20	Jump frequency valid or not while ACC/DEC	0:invalid 1:valid	0	○
F13.21	Running time arrive action	0:keep running 1: alarm fault	0	○
F13.22	Power on time arrive action	0:keep running 1: alarm fault	0	○
F13.23	Switch frequency of ACC time 1/2	0.00Hz~Max. Frequency F00.06	0.00	○
F13.24	Switch frequency of DEC time 1/2	0.00Hz~Max. Frequency F00.06	0.00	○
F13.25	Terminal JOG priority	0:invalid 1:valid	0	○

Function code	Name	Detailed instruction of parameters	Default value	Attribution
F13.26	Frequency detection value (FDT2)	0.00Hz~Max. Frequency F00.06	50.00	○
F13.27	Frequency detection delay value (FDT2)	0.0%~100.0% (FDT2 level)	5.0	○
F13.28	Any arrival detection frequency value 1	0.00Hz~Max frequency F00.06	50.00	○
F13.29	Frequency arrival detection amplitude1	0.0%~100.0% (Max frequency)	0.0	○
F13.30	Any arrival detection frequency value 2	0.00Hz~Max frequency F00.06	50.00	○
F13.31	Any arrival detection frequency range 2	0.0%~100.0% (Max frequency)	0.0	○
F13.32	0 current detection level	0.0%~300.0% 100.0% corresponding motor rated current, no output at stop.	5.0	○
F13.33	0 current detection delay time	0.01s~600.00s	0.10	○
F13.34	Output current over limit	0.0% (no detection) 0.1%~300.0% (motor rated current)	200.0	○
F13.35	Output current over limit detection delay time	0.00s~600.00s	0.00	○
F13.36	Any arrival current 1	0.0%~300.0% (motor rated current)	100.0	○
F13.37	Any arrival current 1range	0.0%~300.0% (motor rated current)	0.0	○
F13.38	Any arrival current 2	0.0%~300.0% (motor rated current)	100.0	○
F13.39	Any arrival current 2 range	0.0%~300.0% (motor rated current)	0.0	○
F13.40	Timing function selection	0:invalid 1:valid	0	☆
F13.41	Timer running time selection	0:F13.42 setting 1:A11 2:A12 3:reserved Analog input range corresponding to F13.42	0	☆
F13.42	Timer running time	0.0min~6500.0min	0.0	☆
F13.43	A11input voltage protection value high limit	0.00V~F13.44	3.10	○
F13.44	A11input voltage protection value low limit	F13.43~11.00V	6.80	○
F13.45	Module temperature arrive	0℃~100℃	75	○
F13.46	Radiate fan control	0:fan runs while inverter running 1: fan always run	0	○
F13.47	Wake up frequency	Sleep frequency (F13.48) ~Max frequency (F00.06)	0.00	○
F13.48	Sleep frequency	0.00Hz~Wake up frequency (F13.47)	0.00	○
F13.49	Current running arrive time	0.0s~6500.0Mins	0.0	○
F13.50	Output power correction factor	0.0~200.0%	100.0	○
		F14 Group User define functions		
		F15 Group Factory parameters		
		F16 Group User parameters		
F16.00	Display of function parameters	Unit place: B00 parameter group display selection 0: not display 1: display	11	○

Function code	Name	Detailed instruction of parameters	Default value	Attribution
		Ten place: A00-A15 parameter group display selection 0: not display 1: display		
F16.01	Display of special parameters	Unit place: user determine parameter group display selection 0: not display 1: display Ten place: user change parameter group display selection 0: not display 1: display	01	○
F16.02	Function parameter modify control	0: can modify 1: can not modify	0	○
A00 Torque control and limited parameter				
A00.00	Speed/torque control mode	0:speed control 1:torque control	0	☆
A00.01	Drive torque high limit source	0:number setting (A00.03) 1:AI1 2:AI2 3:reserved 4:high speed pulse setting 5:communication setting 6:min (AI1,AI2) 7:MAX (AI1,AI2) 1-7 full range corresponding to A00.03	0	☆
A00.02	Braking torque high limit source	0:number setting (A00.03) 1:AI1 2:AI2 3:reserved 4:high speed pulse setting 5:communication setting	0	☆
A00.03	Drive torque high limit number setting	-200.0%~200.0%	150.0	○
A00.04	Torque filter			●
A00.05	Torque control FWD Max frequency	0.00Hz~Max frequency F00.06	50.00	○
A00.06	Torque control REV Max frequency	0.00Hz~Max frequency F00.10	50.00	○
A00.07	Torque ACC time	0.00s~650.00s	0.00	○
A00.08	Torque DEC time	0.00s~650.00s	0.00	○
A01 Vitual I/DO parameters				
A01.00	Vitual VDI1 terminal function selection	0~59	59	☆
A01.01	Vitual VDI2 terminal function selection	0~59	59	☆
A01.02	Vitual VDI3 terminal function selection	0~59	59	☆

Function code	Name	Detailed instruction of parameters	Default value	Attribution
A01.03	Vital VDI4 terminal function selection	0~59	59	☆
A01.04	Vital VDI5 terminal function selection	0~59	59	☆
A01.05	VDI terminal valid state source	0:inner connect vital Dox 1:function code set valid or not Unit place:vital VDI1 Ten place:vital VDI2 Hundred place:vital VDI3 Thousand place:vital VDI4 Ten thousand place:vital VDI5	11111	☆
A01.06	Vital VDI terminal function code set valid state	0: invalid 1: valid Unit place:vital VDI1 Ten place:vital VDI2 Hundred place:vital VDI3 Thousand place:vital VDI4 Ten thousand place:vital VDI5	11111	○
A01.07	AI1 terminal function selection (be DI)	0~59	59	☆
A01.08	AI2 terminal function selection (be DI)	0~59	59	☆
A01.09	AI3 terminal function selection (be DI)	0~59	59	☆
A01.10	A1 be DI valid state selection	0:high electrical level 1:low electrical level Unit place:AI1 Ten place:AI2 Hundred place:reserve	111	☆
A01.11	Vital VDO1 output selection	0~41 (can be selected as communication control)	41	○
A01.12	Vital VDO2 output selection	0~41 (can be selected as communication control)	41	○
A01.13	Vital VDO3 output selection	0~41 (can be selected as communication control)	41	○
A01.14	Vital VDO4 output selection	0~41 (can be selected as communication control)	41	○
A01.15	Vital VDO5 output selection	0~41 (can be selected as communication control)	41	○
A01.16	VDO1 output delay time	0.0s ~ 3600.0s	3600.0	○
A01.17	VDO2 output delay time	0.0s ~ 3600.0s	3600.0	○
A01.18	VDO3 output delay time	0.0s ~ 3600.0s	3600.0	○
A01.19	VDO4 output delay time	0.0s ~ 3600.0s	3600.0	○
A01.20	VDO5 output delay time	0.0s ~ 3600.0s	3600.0	○

Function code	Name	Detailed instruction of parameters	Default value	Attribution
A01.21	VDO output terminal valid state selection	0-positive logic; 1-negative logic Unit place:VDO1 Ten place:VDO2 Hundred place:VDO3 Thousand place:VDO4 Ten thousand place:VDO5	11111	☆
A02 Group Motor 2 parameters				
A02.00	Motor type	0: normal asynchronous motor 1: change frequency asynchronous motor	0	☆
A02.01	Rated power of asynchronous motor	Depend on model	3.7	☆
A02.02	Rated frequency of asynchronous motor	0.01Hz~ (Max. frequency)F00.06	50.00	☆
A02.03	Rated speed of asynchronous motor	1rpm~65535rpm	1460	☆
A02.04	Rated voltage of asynchronous motor	1V~2000V	380	☆
A02.05	Rated current of asynchronous motor	0.01A~655.35A (inverter power <=55kw) 0.1A~6553.5A (inverter power >55kW)	9.00	☆
A02.06	Stator resistance of asynchronous motor	0.001Ω~65.535Ω (inverter power <=55kW) 0.0001Ω~6.5535Ω (inverter power >55kW)	1.204	☆
A02.07	Rotor resistance of asynchronous motor	0.001Ω~65.535Ω (inverter power <=55kW) 0.0001Ω~6.5535Ω (inverter power >55kW)	0.908	☆
A02.08	Inductance of asynchronous motor	0.01mH~655.35mH (inverter power <=55kW) 0.001mH~65.535mH (inverter power >55kW)	5.28	☆
A02.09	Mutual inductance of asynchronous motor	0.1mH~6553.5mH (inverter power <=55kW) 0.01mH~655.35mH (inverter power >55kW)	158.6	☆
A02.10	Non-load current of asynchronous motor	0.01A~A02.03 (inverter power <=55kw) 0.1A~A02.03 (inverter power >55kW)	4.24	☆
A02.11	Motor parameters autotuning	0: no actuation 1: dynamic autotuning (no load) 2: static autotuning 1 (with load) 3: static autotuning 2 (with load)	0	☆
A02.12	Encoder pulse quantity	1~65535	1024	☆
A02.13	Encoder type	0: ABZ incremental encoder 1: UVW incremental encoder 2: Resolver encoder 3: Sin-Cos encoder	0	☆

Function code	Name	Detailed instruction of parameters	Default value	Attribution
		4: Line-saving UVW encoder		
A02.14	Speed feedback PG selection	0:local PG 1:expand PG 2:HDI high speed pulse input (DI5)	0	☆
A02.15	ABZ encoder AB phase sequence	0:positive 1:negative	0	☆
A02.16	Encoder install position angle	0.0 ~ 359.9°	0.0	☆
A02.17	UVW signal phase sequence	0:positive 1:negative	0	☆
A02.18	UVW signal 0 position angle	0.0 ~ 359.9°	0.0	☆
A02.19	Resolver pole pair number	1~65535	1	☆
A02.20	Reserve			●
A02.21	Speed feedback PG disconnection detection time	0.0: no action 0.1s~10.0s	0.0	☆
A02.22	Speed loop proportional gain 1	1~100	30	○
A02.23	Integral time of speed loop 1	0.01s ~ 10.00s	0.50	○
A02.24	Switch frequency1	0.00 ~ A02.27	5.00	○
A02.25	Speed loop proportional gain 2	1~100	20	○
A02.26	Integral time of speed loop 2	0.01s~10.00s	1.00	○
A02.27	Switch frequency2	A02.24~max frequency F00.06	10.00	○
A02.28	Slip gain of vector control	50%~200%	100	○
A02.29	SVC Speed feedback filtering time	0.000s~1.000s	0.050	○
A02.30	Overexcitation gain of vector control	0~200	64	○
A02.31	Speed control (drive) torque max limit digital setting	0.0%~200.0%	150.0	○
A02.32	Speed control (drive) torque max limit source	0:A02.31 set 1:A11 2:A12 3:reserved 4:HDI high speed pulse setting 5:communication setting 6:min(A11, A12) 7:MAX(A11,A12) 1-7 Full scale corresponding to A02.31	0	○
A02.33	Speed control (braking) torque max limit source	0:A02.34 set 1:A11 2:A12 3:reserved 4:HDI high speed pulse setting 5:communication setting 6:min(A11, A12) 7:MAX(A11,A12) 1-7 Full scale corresponding to A02.34	0	●
A02.34	Speed control (braking) torque max limit digital setting	0.0%~200.0%	150.0	●
A02.35	Proportional gain of M axis	0~60000	2000	○

Function code	Name	Detailed instruction of parameters	Default value	Attribution
A02.36	Integral gain of M axis	0~60000	1300	○
A02.37	Proportional gain of T axis	0~60000	2000	○
A02.38	Integral gain of T axis	0~60000	1300	○
A02.39	Integral attribute of speed loop	Unit place:integral separation 0: Integral always valid 1: speed loop integral separation	0	○
A02.40	Synchronous motor weak magnetic mode selection	0:no weak magnetic 1:direct calculate 2:Automatic adjust	0	○
A02.41	Over modulation enable selection	0:forbid 1:enable	0	○
A02.42	Maximum output voltage coefficient	100%~110%	105	☆
A02.43	Maximum torque coefficient in weak magnetic region	50%~200%	100	○
A02.44	Selection of generation (braking) torque enabling under speed model	0:disable 1:enable	0	○
A02.45	Motor control mode	0:sensorless vector control (SVC) 1:vector control with sensor (FVC) 2:V/F control	2	☆
A02.46	ACC time / DEC time selection	0: same as motor 1 1: ACC time / DEC time 1 2: ACC time / DEC time 2 3: ACC time / DEC time 3 4: ACC time / DEC time 4	0	○
A02.47	Motor torque magnify	0.0%: automatic torque magnify 0.1%~30.0%	1.0	○
A02.48	reserve	reserve	0	●
A02.49	Oscillation suppression gain	0~100	0	○
A03 Group		Reserved		
A04 Group		Reserved		
A05 Group Control Optimization Parameters				
A05.00	DPWM switch high limit frequency	5.00Hz~max frequencyF00.06	8.00	○
A05.01	PWM modulate mode	0:Asynchronous modulate 1:Synchronous modulate	0	○
A05.02	Dead zone compensation mode selection	0:no compensation 1:compensation mode 1 2:compensation mode 2	1	○
A05.03	Random PWM	0:not choose 1~10: random depth selection	0	○
A05.04	Cycle by cycle current limiting enabling	0:not enable 1: enable	1	○
A05.05	Current detection delay compensation	0~100	5	○
A05.06	Under voltage point setting	200.0v~2000.0v set by model 220v:200v 380v:350v 480v:350v	350.0	○

Function code	Name	Detailed instruction of parameters	Default value	Attribution
		690v:650v 1140v:1100v		
A05.07	reserved	reserved	2	☆
A05.08	Dead zone time adjust	100%~200%	150	☆
A05.09	Over voltage point setting	200.0v~2200.0vset by models 220v:400v 380v:810v	810.0	☆
A06 Group AI curve setting				
A06.00	Curve4min input	-10.00~A06.02	0.00	○
A06.01	Curve4min input set	-100.0%~100.0%	0.0	○
A06.02	Curve4inflection point 1input	A06.00~A06.04	3.00	○
A06.03	Curve4inflection point 1input set	-100.0%~100.0%	30.0	○
A06.04	Curve4inflection point 2input	A06.02~A06.06	6.00	○
A06.05	Curve4inflection point 2input set	-100.0%~100.0%	60.0	○
A06.06	Curve4Max input	A06.04~10.00	10.00	○
A06.07	Curve4Max input set	-100.0%~100.0%	100.0	○
A06.08	Curve5min input	-10.00~A06.10	-10.00	○
A06.09	Curve5min input set	-100.0%~100.0%	-100.0	○
A06.10	Curve5inflection point 1input	A06.08~A06.12	-3.00	○
A06.11	Curve5inflection point 1input set	-100.0%~100.0%	-30.0	○
A06.12	Curve5inflection point 2input	A06.10~A06.14	3.00	○
A06.13	Curve5inflection point 2input set	-100.0%~100.0%	30.0	○
A06.14	Curve5Max input	A06.12~10.00	10.00	○
A06.15	Curve5Max input set	-100.0%~100.0%	100.0	○
A06.16 ~23	Reserved	Reserved	0	●
A06.24	AI1set jump point	-100.0%~100.0%	0.0	○
A06.25	AI1set jump range	0.0~100.0%	0.5	○
A06.26	AI2set jump point	-100.0%~100.0%	0.0	○
A06.27	AI2set jump range	0.0~100.0%	0.5	○
A06.28	Reserve	Reserve	0.0	○
A06.29	Reserve	Reserve	0.5	○
A07 Group Reserved				
A08 Group Point-to-point communication				
A08.00	Main-slave control function selection	0: invalid 1: valid	0	☆
A08.01	Main-slave selection	0: main machine 1: slave machine	0	☆
A08.02	Main-slave information interaction	ld 3 Unit place: slave machine command follow 0: slave machine not follow main machine run command to run	11	☆

Function code	Name	Detailed instruction of parameters	Default value	Attribution
		1: slave machine follow main machine run command to run Ten place: slave machine fault information transmit 0: slave machine fault information not transmit 1: slave machine fault information transmit Hundred place: main machine display slave machine off line 0: slave machine off line main machine not alarm fault 1: slave machine off line main machine alarm fault (Err16)		
A08.03	Main machine send data function selection	0: run frequency 1: aim frequency	0	☆
A08.04	Receive data 0 bias	-100.00%~100.00%	0.00	○
A08.05	Receive data gain	-10.00~10.00	1.00	○
A08.06	point-to-point communication disconnection detection time	0.0~10.0s	1.0	☆
A08.07	point-to-point communication main machine data send cycle	0.001~10.000	0.001	☆
A08.08	Frequency receive data 0 bias	-100.00%~100.00%	0.00	○
A08.09	Frequency receive data gain	-10.00~10.00	1.00	○
A08.10	Slave machine frequency FWD max bias	0.00~100.00%	10.00	○
A08.11	Window	0.20Hz~10.00Hz	0.50	○
A09 group Water supply parameters				
A09.00	Set pressure	0.000~60.000Mpa	0.000	○
A09.01	Feedback full range max pressure	0.000~60.000Mpa	1.000	○
A09.02	Lower limit pressure	0.000~60.000Mpa	0.000	○
A09.03	Upper limit pressure	0.000~60.000Mpa	1.000	○
A09.04	Wake up pressure	0.000~60.000Mpa	0.000	○
A09.05	Dormancy pressure	0.000~60.000Mpa	1.000	○
A09.06	Process time of feedback pressure bigger than dormancy pressure	0.0s~2500.0s	10.0	○
A09.07	Frequency dormancy	0.0Hz~max frequency (F00.06)	20.00	○
A09.08	Keep time of frequency lower than dormancy frequency	0.0s~2500.0s	10.0	○

Function code	Name	Detailed instruction of parameters	Default value	Attribution
A09.09	Wake up delay time	0.0s~2500.0s	0.0	○
A09.10	Reserved			
A09.11	Dormancy selection	0:frequency Dormancy valid ; 1: pressure Dormancy valid ;	0	○
A09.12	Keypad analog filter	0~8	3	○
A10~A15 group Reserved				
b00 group Display				
b00.00	Running frequency	Unit: Hz	0.01	●
b00.01	Set frequency	unit:Hz	0.01	●
b00.02	Bus voltage	unit:V	0.1	●
b00.03	Output voltage	unit:V	1	●
b00.04	Output current	unit:A	0.01	●
b00.05	Output power	unit:kw	0.1	●
b00.06	Output torque	unit:%	0.1	●
b00.07	DI input state		0x0000	●
b00.08	DO output state		0x0000	●
b00.09	AI1voltage	unit:V	0.01	●
b00.10	AI2voltage/current	unit:V/mA	0.01	●
b00.11	Reserved	Reserved	0.01	●
b00.12	Count value		1	●
b00.13	Depth value		1	●
b00.14	Load speed display		1	●
b00.15	PID set	unit:%	1	●
b00.16	PID feedback	unit:%	1	●
b00.17	PLC steps		1	●
b00.18	Input pulse frequency	unit:kHz	0.01	●
b00.19	Feedback speed	unit:Hz	0.01	●
b00.20	Remaining running time	unit:min	0.1	●
b00.21	AI1 before correction voltage	unit:V	0.001	●
b00.22	AI2 before correction voltage/current	unit:V/mA	0.001	●
b00.23	keypad potentiometer AI0 before correction voltage	unit:V	0.001	●
b00.24	Linear speed	unit:m/min	1	●
b00.25	Current power on time	unit:min	1	●
b00.26	Current running time	unit:min	0.1	●
b00.27	Input pulse frequency	unit:kHz	1	●
b00.28	Communication setting	unit:Hz	0.01	●
b00.29	Reserved			●
b00.30	Main frequency X display	unit:Hz	0.01	●
b00.31	Auxiliary frequency Y display	unit:Hz	0.01	●
b00.32	Check any memory address value		1	●
b00.33	Synchronous machine rotor position	unit:°	0.1	●

Function code	Name	Detailed instruction of parameters	Default value	Attribution
b00.34	Reserved		1	●
b00.35	Aim torque	unit:%	0.1	●
b00.36	Reserved		1	●
b00.37	Power factor angle	unit:°	0.1	●
b00.38	Reserved		1	●
b00.39	VF separation aim voltage	unit:V	1	●
b00.40	VF separation output voltage	unit:V	1	●
b00.41	DI input state visual display		1	●
b00.42	DO input state visual display		1	●
b00.43	DI function state visual display1(function 01~function 40)		1	●
b00.44	DI function state visual display (function 41~function 80)		1	●
b00.45	Fault information		1	●

CHAPTER 5 COMMUNICATION PROTOCOL

The CT100G series inverters provide RS485 communication interface. You can realize centralized control via PC/PLC (set the run commands and function parameters of the inverter, read the work state and fault information of the inverter) to meet the specific requirements.

1. Content

The serial communication protocol defines the content and format of the transmission information for serial communication, including master polling (or broadcast) format, master encoding method including the required function codes, transmission data and error check. The slave response also uses the same structure including actuation confirmation, return data and error check. If an error occurs when the slave receives information or the slave cannot complete the actuation required by the master, it will feedback a response of fault information to the master.

2. Application mode

The inverter has access to "single- master multi-slaves" PC/PLC control network with RS485 bus.

Support Modbus protocol and RTU format; broadcast address is 0 and slave address can be set to 1~247.

3. Bus structure

(1) interface mode

RS485 (CT100G terminals: 485 + and 485-) hardware interface

(2) transmission mode

Asynchronous serial, half duplex transmission. At the same time, only one can send data and the other can receive data for the master and the slave. Data in the serial asynchronous communication process, in the form of a message, can be sent one by one frame.

(3) topology structure

Single-master multi-slaves network, the slave address in the network must be unique.

4. Description of the protocol

CT100G series inverter communication protocol is an asynchronous serial master-slave Modbus communication protocol and only one device (master) in the network can establish a protocol (called "query/command"). Other devices (slaves) can only provide data to respond to the master's "query/command" or make the corresponding actuation according to the master's "query/command". The master refers to a personal computer (PC), an industrial control device or a programmable logic controller (PLC), etc. The slave is CT100G inverter. The master can communicate with a single slave as well as send a broadcast message to all slaves. For the master's single "query/command", the slave has to return a message (called a response), for the master's broadcast message,

the slaves do not need to respond to the master.

5. Communication data format

The Modbus protocol communication data format of CT100G series inverters is as follows:

In RTU mode, the minimum interval time should be at least 3.5 bytes for message transmission, which is the easiest way to achieve a variety of character time at the baud rate. The first transmitted field is the device address. The transmitted characters can be hexadecimal 0...9 and A...F. The network device constantly detects the network bus, even during the interval time. When the first field (address field) is received, the corresponding device decodes next transmitting character. After the last transmitting character, the interval time of at least 3.5 bytes marks the end of the message. A new message can start after this pause.

The whole message frame is a continuous transmitting flow. If there is an interval time of more than 1.5 bytes before the frame is completed, the receiving device will renew the uncompleted message and assume that the next byte is the address field of a new message. As such, if the new message follows the previous message within the interval time of 3.5 bytes, the receiving device will deal with it as the same with the previous message. If these two phenomena all happen during the transmission, the CRC will generate a fault message to respond to the sending devices.

RTU frame format

START	Interval time of 3.5 bytes
ADR	Communication address: 1~247
CMD	03: read slave parameters; 06: write slave parameters
DATA (N-1)	Function parameter address, function parameter number, function parameter value etc.
DATA (N-2)	
.....	
DATA (0)	
CRC CHK low bit	Detection value: CRC
CRC CHK high bit	
END	Interval time of 3.5 bytes

CMD (command instruction) and DATA

Command code: 03H, read N words (at most 16 words can be read)

For example: the baud rate 19200bps, even check (E, 8,1) for RTU, read continuous two data from the inverter F06.19 with the slave address of 01.

Master command message

ADR	01H
CMD	03H